

Cost benefit of biomass supply and pre-processing

Shahab Sokhansanj, P.Eng., University of British Columbia
Jim Fenton, President, Jim Fenton and Associates, Edmonton

March 2006



A BIOCAP
Research Integration Program
Synthesis Paper





This paper was supported by BIOCAP through a targeted research program.

The report reflects the research findings and opinions of the research team and not necessarily those of BIOCAP Canada.

SUMMARY

This paper deals with a detailed analysis of costs, energy input, and carbon emissions for biomass collection and pre-processing enterprises in Canada. The enterprises fill the gap between the biomass producers and biorefinery, ensuring uninterrupted flow of biomass from field to biorefinery. A typical enterprise engages in securing biomass, pre-processing it to a form and format that satisfies the quality and quantity requirements of biorefinery, at a competitive price. The responsibilities of a biomass enterprise may include assessing biomass availability, organizing contractual agreements, collection, storage, pre-processing, and just-in-time delivery to a biorefinery. Biomass species for collection and supply that have been analyzed include crop residues and switchgrass. Preprocessing, storage, and transport operations are not specific to a particular crop.

A dynamic model that simulates the collection, storage, transport, and pre-processing operations for supplying agricultural biomass to biorefineries was used for the analysis. A number of current and potential flow sheets to supply biomass are presented. The cheapest collection option is using a single step harvest system where the material is collected and transported to the side of the field. We also discuss potential operations for increasing the bulk density and flowability of biomass by granulating (pelletizing) the biomass. Alternate cases for transporting biomass using rail and pipeline are also discussed.

We show that the realistic quantity of biomass available for collection is a fraction of the total biomass based on gross yield and biomass to grain ratios. The availability could be as low as 50% under best conditions considering soil health, crop rotations, and harvest machine capability. We also show that the biomass supply basin may need to be expanded in order to deal with variability in yield, harvest window and annual cropping practices.

The paper discusses methods of harvesting crop residues and Switchgrass, and opportunities to incorporate several operations into a single piece of equipment. The amalgamation of operations reduces costs by reducing the capital costs and number of trips made on the fields. While such singlepass equipment are not currently available they could be developed as the biomass to bioenergy industry evolves. We also make a case where densification of biomass to granules will be a key to the success of the industry.

The paper discusses the logistics of biomass collection, storage, and transport to the biorefinery. We show that the biomass can be collected in the form of bales and stacked next to the field. The stacked biomass is then transported directly to the biorefinery or to a satellite depot for storage. The biomass may be partially processed at these satellite storage sites before being shipped to the biorefinery.

We use IBSAL (Integrated Biomass Supply Analysis & Logistics) Model developed at the Oak Ridge National Laboratory to calculate the collection and transport costs. For collection we show that the most cost effective handling of biomass is by loafing – the harvest machine forms a large stack as the machine travels the field. The stack is then taken to the side of the field and unloaded. The cost of loafing is roughly 19 \$ t⁻¹ vs. more than 23 \$ t⁻¹ for baling (large squares – 1.2 m x 1.2 m x 2.4 m). The cost of piling and silaging biomass at present is more than 35\$ t⁻¹, but these techniques have a great potential to help increase biomass availability in the future.

IBSAL was used to calculate the cost of transporting biomass from stacks or satellite depots to the biorefinery. Costs included loading, transporting, unloading, stacking, and grinding at the biorefinery. The transport cost for trucks depended on travel distance, and also on whether it was a fixed distance or an aggregate of distances from a minimum to a maximum. For a fixed distance of 100 km (a maximum distance) the cost was roughly 25 \$ t⁻¹ but for an aggregate distance of 20 to 100 km the cost was 19 \$ t⁻¹. The cost for rail depended mostly on loading and loading and less on the transport distances. For pipeline transport the cost increased with the loading and unloading as well as with distances because capital costs increases with increased distances.

We calculate the cost of making pellets was roughly 30 \$ t⁻¹ for a 20,000 t throughput pelleting plant. This cost included drying of biomass from 40% to 10% (mass wet basis) using biomass as a source of heat for drying. The cost may further decreased by increasing tonnage throughput and accessing lesser moisture content biomass. The cost of cubing of biomass (stover) was similar to the cost of pelleting.

The overall cost of delivery of biomass depends on many factors, but the largest factors are the bulk density of the biomass, its moisture content, and the distance to be transported. Granulated biomass is easy and safe to handle, especially with the existing well developed grain handling facilities. The cost of delivered granulated biomass may range from a minimum of 46 \$ t⁻¹ to slightly more than 73 \$ t⁻¹. This cost does not include a payment to the producer of the biomass, which is estimated at a nominal 10 \$ t⁻¹.

Keywords: Biomass; Harvest and collection; Handling and pre-processing; Transport; Supply chain and logistics; Cost, Energy and emissions

ACKNOWLEDGEMENTS

We acknowledge financial support from BIOCAP Foundation Canada for development of this paper. This paper is heavily drawn from input and output of the IBSAL Model developed by author at the Oak Ridge National Laboratory (Tennessee, U.S.A.) The funding for IBSAL development was provided in parts from the Office of Biomass Program of the U.S. Department of Energy and the Natural Sciences and Engineering Research Council of Canada.

CONTENTS

SUMMARY	2
ACKNOWLEDGEMENTS	4
1. INTRODUCTION	8
2. BIOMASS YIELD, SUPPLY AREA, AND SCHEDULE	9
2.1 Yield	
2.2 Supply area	
2.3 Supply schedule	
3. BIOMASS HARVEST AND COLLECTION	11
3.1 Switchgrass	
3.2 Crop Residue	
3.3 Cutting and field drying	
3.4 Collection	
4. BIOMASS PREPROCESSING	16
4.1 Operations for dense biomass	
5. TRANSPORTATION	18
5.1 Transport equipment	
5.2 Logistics	
6. COSTS	20
6.1 Collection costs	
6.2 Transport costs	
6.3 Granulation costs	
7. CONCLUDING REMARKS	26
8. REFERENCES	27
APPENDIX A	
APPENDIX B	
APPENDIX C	

LIST OF FIGURES

Figure 1. Biomass Supply enterprise as an integral part of biomass to biorefinery Chain

Figure 2. Advanced options for harvest and collection of switchgrass. The outer box (thin line) indicates that the operations contained in the box can be combined into a single equipment.

Figure 3. Options for collecting and stacking wheat straw.

Figure 4. Options for collecting and stacking stover

Figure 5. Diagram a macerator used for harvesting and macerating green grasses. The diagram is from the web site: http://www.pami.ca/hay_maceration.htm

Figure 6. Moisture content of corn stalks (solid line and circles) and of the grain (diamonds) after grain maturity date (Sokhansanj et al. 2006).

Figure 7. Flow chart for pre processing of biomass to pellets or to small particles. Pelleting is done when material travels a long distance to biorefinery.

Figure 8. Bulk density vs. mean particle size of biomass

Figure 9. Transporting biomass from location A to location B. Various of modes of transport are depicted here. There may be one or a combination of more one transport modes are involved.

Figure 10. Logistics of supplying biomass to a biorefinery.

Figure 11. Overall structure of IBSAL collection modules defining input and output.

Figure 12. logistics of biomass collection and temporary storage on a typical size farms in mid-west (U.S. and Canada)

Figure 13. Fixed and variable distance transport

Figure 14. Transport cost of switchgrass using three modes of transport. For pipeline an annual capacity of 1 million t is assumed.

LIST OF TABLES

Table 1. Calculations of the net yield for three crops

Table 2. Calculation of cultivated area and the supply area for biomass (all weights are in dry mass)

Table 3. Typical progress of harvest for straw, stover, and switchgrass (%)

Table 4 Bulk density of biomass

Table 5. Cost, energy and emission components for each unit operation in biomass collection *

Table 6. Cost, energy, and emissions for each unit operation in transporting bales for a variable distance of between 20 and 100 km and a fixed distance of 100 km.

Table 7. Cost, energy, and emissions for each unit operation in transporting grind and pellets for a variable distance of between 20 and 100 km.

Table 8. Cost and energy consumption equations for transporting biomass using truck, rail, or pipeline*

Table 9. Cost of biomass pellet production for the base case (2004 US dollars)

Table 10. Minimum and maximum cost of biomass supply (20 to 100 km distance) including granulation (pelleting)

Table A1. Equipment size and specification used in the model to calculate costs and energy input for harvest, collection, and transport (truck).

1. INTRODUCTION

Feedstock cost constitutes about 35-50% of the total production cost of ethanol or power. The actual percentage depends upon biomass species, yield, location, climate, local economy, and the type of systems used for harvesting, gathering and packaging, processing, storing, and transporting of biomass as a feedstock. The following is a list of feedstock requirements to ensure the biorefineries succeed

- Identify quantities, quality of biomass, delivery costs for the year round supply of biomass.
- Conduct resource assessment considering mix of available biomass species, annual yield variations, environmental factors, seasonality, and competitive demands for biomass.
- Optimize for the least cost equipment and infrastructure for timely harvest, densifying, storing, and transporting of the biomass,
- Develop regional and national strategies for locating biorefineries and organizing supply chains with respect to biomass cost and availability.

Figure 1 shows a diagram of biomass-to-product thread from production to biorefinery. The type of biorefinery may range from biomass to heat and power or to production of chemicals and liquid fuels. Biomass production can be from agricultural and forestry activities, municipal and industrial wastes. The activities within the red oval identify the current and probable future biomass supply enterprises. Biomass is collected in a distributed system at the farm or at the forest level. The collected biomass is transported either a short distance (10-40 km) or a long distance for storage and/or preprocessing. Preprocessing may include one or a combination of several of size reduction, fractionation, sorting, and densification. The storage of wet biomass may also impart biochemical and physical modifications to the biomass. We call this in-store pre processing. The pre-processed biomass is transported to biorefinery where it is fed directly into the conversion reactor.

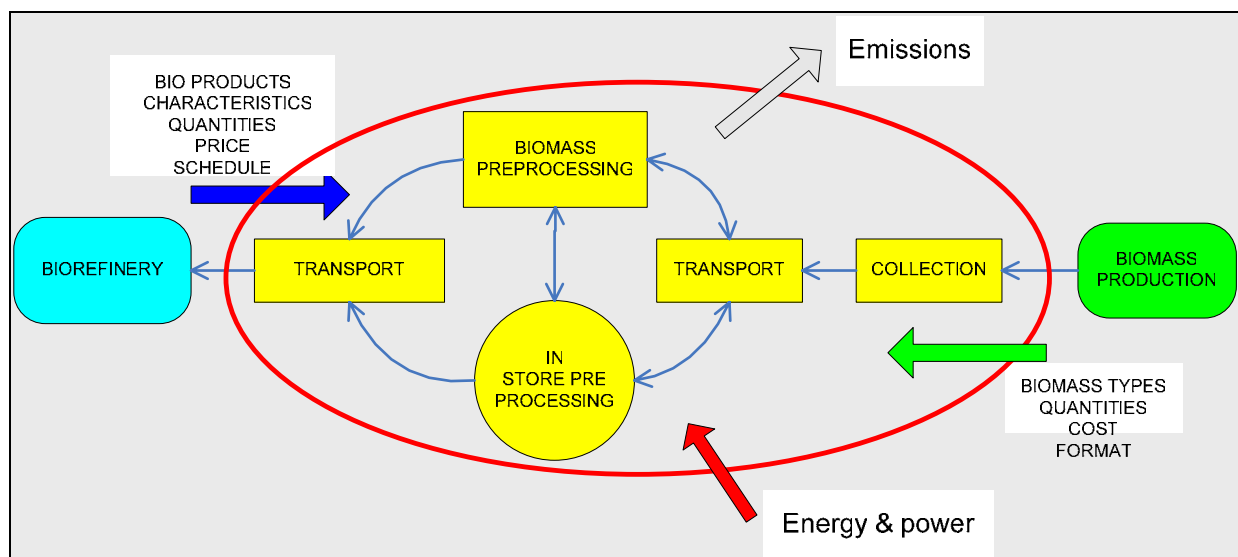

Figure 1. Biomass Supply enterprise as an integral part of biomass to biorefinery chain

The arrows on the diagram show the flow of material and information. The information flow (blue line) from biorefinery to biomass supply enterprise includes quality specifications for biomass, i.e. moisture content, particle size, cellulose and lignin content. Important information for logistics includes quantities and delivery schedules and price. In response to demands, the production side provides biomass to the supply system (green arrow). The supply system uses energy (red arrow) and power to collect, pre process, and transport biomass. The system will give off emissions (grey arrow) that need to be minimized.

The objective of this paper is to cast a vision of biomass supply system for a mature bio economy and provide a cost benefit analysis of the biomass supply system. We use a high yielding Switchgrass production scenario and several cases of supplying biomass crop residues to demonstrate this vision. Our base case scenario will be a baling system where biomass is baled in round bales and transported as is to a biorefinery. Although the envisioned mature systems are not fully optimized with respect to cost and energy input and GHG emissions, we are confident that the proposed supply chain is feasible and practical.

2. BIOMASS YIELD, SUPPLY AREA, AND SCHEDULE

2.1 Yield

In case of crop residue, the quantity of biomass is estimated from grain yield and the ratio of straw or stover to grain. In converting yield from grain to biomass, we need to consider definition of bulk density (test weight) of grain and moisture content at which the test weight is given. Once the gross yield of biomass is calculated then we discount this value by a number of factors. Three factors used are the amount of stover that must be left on the field, the fraction of the stover that a machine is capable of removing, and the amount of biomass loss from harvest to biorefinery. The machine performance in removing biomass is affected by the unevenness in the land surface and the height of cut. For instance if the land is furrowed the height of cut must be kept high (more than 150 mm) in order to minimize picking up the dirt. Values listed in Table 1 are not precise and is given here for demonstration purposes. We note that the net yield of straw is 1.8 t/ha, stover 3.7 t/ha, and switchgrass 6.75 t/ha. Please see equation B-3 in appendix B for calculating the net yield.

Table 1. Calculations of the net yield for three crops

Crop	Yield ¹ (bu/ac)	Dry grain t/ha	Straw/ grain ratio	Gross yield (t/ha)	Max fraction removed for soil fertility k_1	Fraction machine can remove k_2	Estimate of losses from harvest to biorefinery k_3	Net yield (t/ha)
Wheat straw	60	3.5	1.3	4.6	0.5	0.75	0.20	1.822
Corn stover	150	8.1	1.0	8.1	0.7	0.75	0.35	3.677
Switchgrass	-	-	-	10.0	0.8	0.75	0.10	6.750

¹ Test weight for wheat at 60 lb/bu at 14% m.c., Test weight for corn at 56 lb/bu at 15.5% m.c. weights are in dry mass.

2.2 Supply area

The supply area is calculated from annual demand for biomass and the net yield of biomass. We used equation B-2 to calculate the cultivated area. Table 2 shows the area of cultivated land to provide 500,000 t of biomass annually.

To calculate the total gross area we then have to apply at least three factors: (1) fraction of the land under biomass cultivation, (2) how often (number of years in between) the producer will supply the biomass, and (3) The sector ratio assuming a circle for the supply area. Table 2 shows that the total area and the radius of supply circle increases substantially depends upon the supply factors (1)- (3).

We should mention that in this analysis we did not consider competition for the same biomass from other sources. For example in many parts corn stover and straw are used for bedding material and feeding to animal. Industrial use of biomass for heat and power, bio fuel production and for other industrial applications (press board, mulch) etc. has not been considered in this analysis. All these factors need to be considered when estimating available biomass and the supply area.

Table 2. Calculation of cultivated area and the supply area for biomass (all weights are in dry mass)

Crop type	Net yield (t/ha)	Annual demand	Cultivated area (ha)	Sectors in which crop is grown (n)	Fraction under crop	How often (years) biomass is available	Total area (ha)	Supply radius (km)
Wheat straw	1.822	500,000	274,403	1.33	0.2	3	5,488,062	132
Corn stover	3.677	500,000	135,983	1.67	0.3	2	1,510,919	69
Switchgrass	6.750	500,000	74,074	2.00	0.1	1	1,481,481	69

2.3 Supply schedule

Harvest of crop residue follows grain harvest. The grain moisture content at its physiological maturity may be in the range of 30-40%. As soon as grain reaches this moisture harvest will start, but not at once. Initially a few will start but the pace of harvest will pick up as the season progresses. Once the peak harvest pass the pace of harvest slows down. In northern climates and for corn that often grows in summer, the harvest is completed before the cold temperatures set in and the work in the field become impossible due to rain or snow. The harvest season ranges from 4 to 10 weeks.

Table 3. Typical progress of harvest for straw, stover, and switchgrass (%)

Week number	Straw	Stover	Switchgrass
0	0	0	0
1	3	4	10
2	9	6	20
3	29	10	30
4	62	13	40
5	80	21	50
6	94	41	60
7	99	61	70
8	-	76	80
9	-	89	90
10	-	96	100
11	-	99	-

Switchgrass can be harvested twice a year with roughly 70% of the yield for first cut and 30% of the yield for the second cut. The yield and mass ratio of the first and the second cut drops for mid western and northern regions of the U.S. (Vogel et al. 2002). In the mid-west U.S., switchgrass starts growing in April or May. Vogel et al. (2002) harvested switchgrass variety Cave 'N Rock from late June to September in Nebraska and Iowa while measuring the biomass yield at the time of each cut. The maximum yield was about 10-12 t ha⁻¹ in mid to late August for both locations. There is a debate whether one additional late cut late in the Fall will increase the total biomass yield. In this study we assume one cut per year. For the present simulation we assume the harvest commences August 1 and continues for the next three months (August, September, and October). The harvest activity stops when daily average temperature is below -5°C. We have assumed a switchgrass yield of 10 t ha⁻¹.

3. BIOMASS HARVEST AND COLLECTION

Harvest and collection constitutes gathering and removing the biomass from field. The operations depends upon the state of biomass on the field. This includes the type of biomass (grass, woody, or crop residue). The moisture content and the end use of biomass also affects the way biomass is collected. For crop residue, the operations need to be organized in companion with the grain harvest. For dedicated crops (grass and woody), the entire process can be staged for recovery of the biomass only. In this section we examined advanced systems that may be used gather dedicated crops and biomass residues.

3.1 Switchgrass

Figure 2 shows four options to collect switchgrass. The first two options are when the biomass is desired as a dry feedstock. The last two harvest methods are when the biomass can be supplied to biorefinery in wet form. Mowing operation is common to all of the gathering scenarios. cuts the plant above ground. The operation is common to all three collection options. The cut material must be removed from the field. The most common method of collecting switchgrass is baling. The switchgrass can also be made into large stacks using loafing machines. These stacks are made in the field and transported to the edge of the field in the same machine. The third and fourth options involve mow and chop and to remove the chops from field as a bulk load.

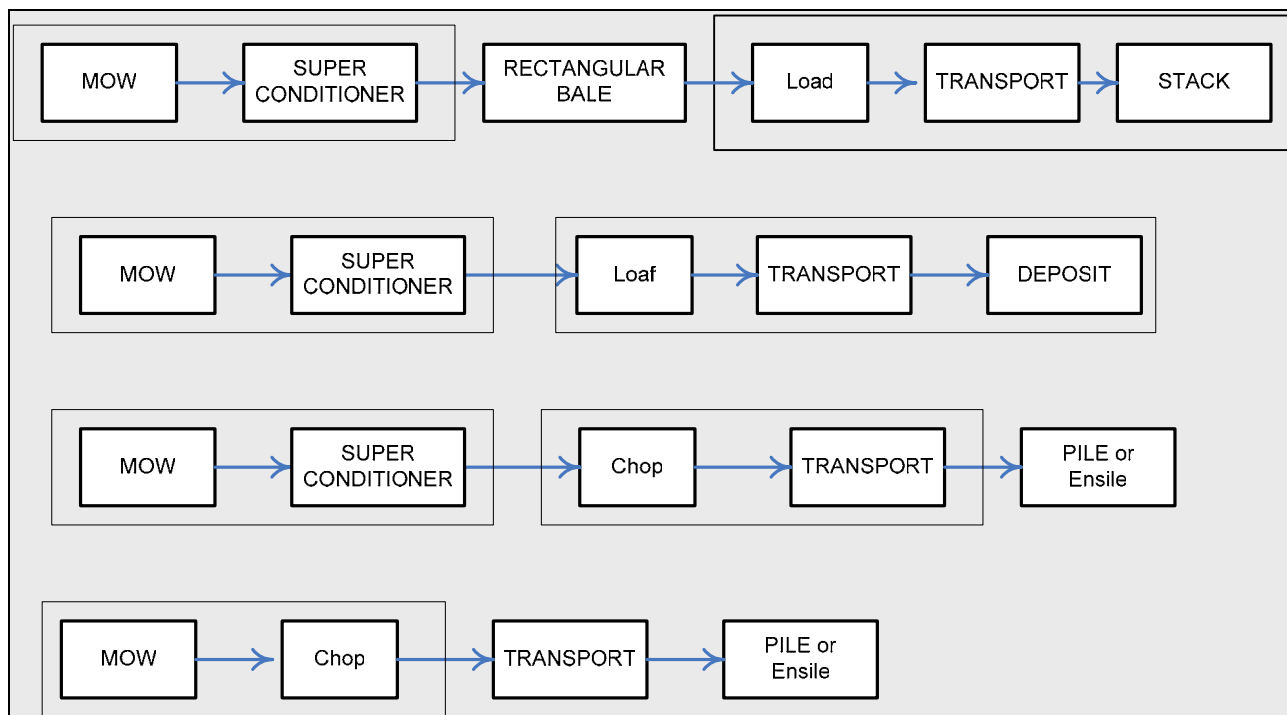

Figure 2. Advanced options for harvest and collection of switchgrass. The outer box (thin line) indicates that the operations contained in the box can be combined into a single equipment.

Technologies are available or perceived to be practical by which several of the operations can be assembled into single equipment. Figure 2 shows the boxes around two or more sequence of these operations that can be combined into a single piece of equipment. The multi function equipment saves time and costs and also improves the quality of harvested biomass. In recent years much effort has gone into combining mowing and conditions of green grasses in a single machine. Balers consume large quantity of power and presently a square baler is towed and powered by a tractor. Loading a

3.2 Crop Residue

For crop residue grain harvest is the precedent and takes the center stage. All of other operations such as residue management and collection take place after so called *grain is in the bin*. This situation may change in future but at the present time this is the case. Figures 3 and 4 show the present and future scenarios for crop residue harvest. The two are slightly different because in case of wheat most of the straw is cut and passed through the combine.

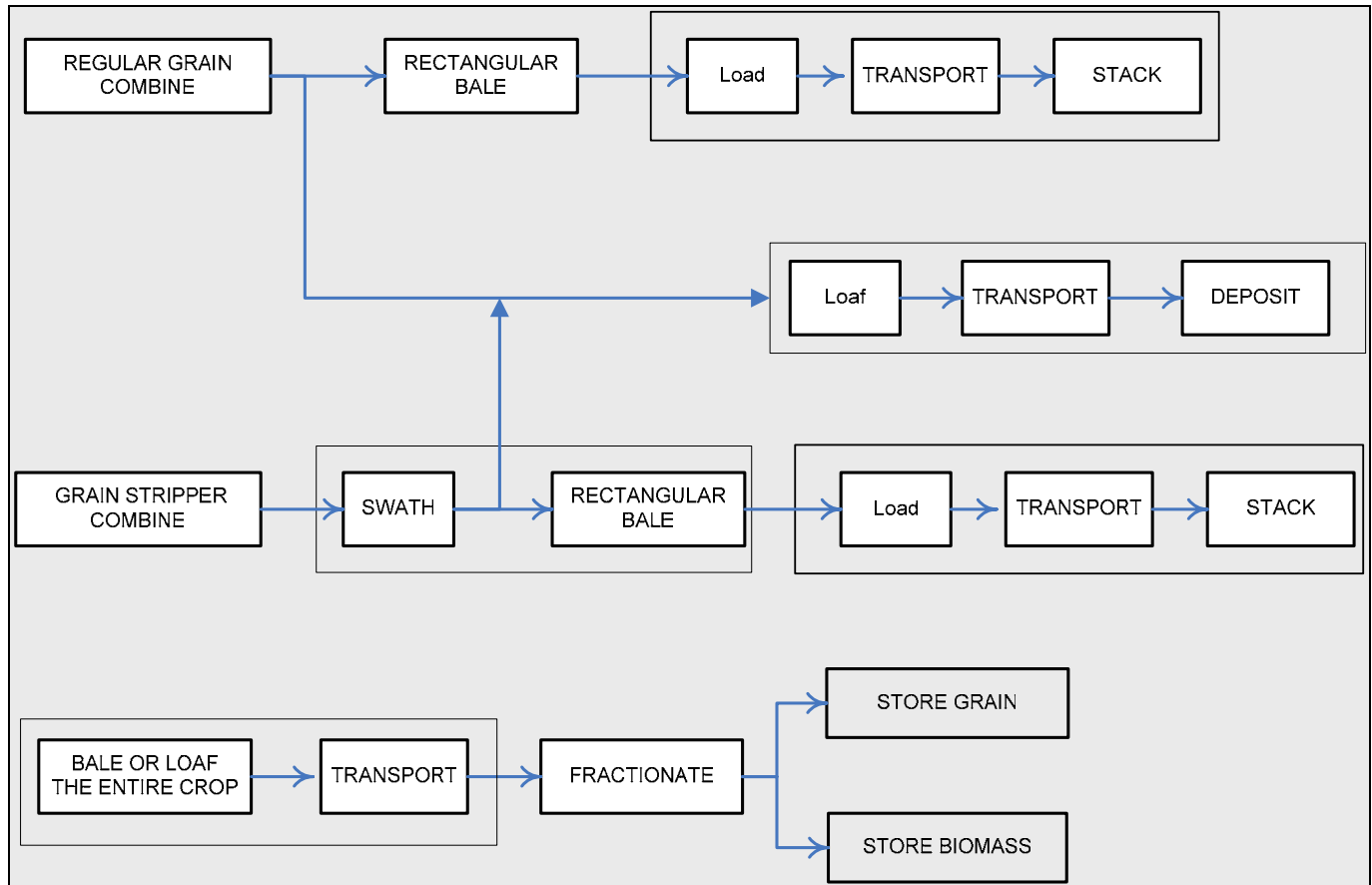

Figure 3. Options for collecting and stacking wheat straw.

In case of corn, a combines takes a small portion of the corn stalks. The majority of the corn stalk left in the field is anchored to the ground. The stalks need to be shredded before a baler can pick it up. Figure 3 also shows the use of new stripper headers for harvesting grain. Stripper headers strip the grain from the stalk and leave the reaming stalks in the field. The straw stalks then need to be cut and placed in a swath for baling. Recent tests in Canada has shown improved biomass yield and quantity when conventional commercial (rotary and cylinder) combines were equipped with stripper headers.

Loafing is an attractive option because collection, densifying, and transport to the side of the farm will be done with a single equipment. Loafing of stover is practiced in Iowa but its performance with strew and switchgrass is unknown. Corn stalk moisture is high especially early in the season. One option is to chop the high moisture stover and store it in a bunker silo as silage. This option is under investigation.

3.3 Cutting and field drying

Mowing may be combined with conditioning where the cut material passes through two or several rollers.

The rollers break the stems of the green plant at several points along the stalk. The bruise and cut provide escape routes for the plant moisture to evaporate quickly. Various degrees of maceration or severe bruising and cutting (super conditioning) have been developed in recent years.

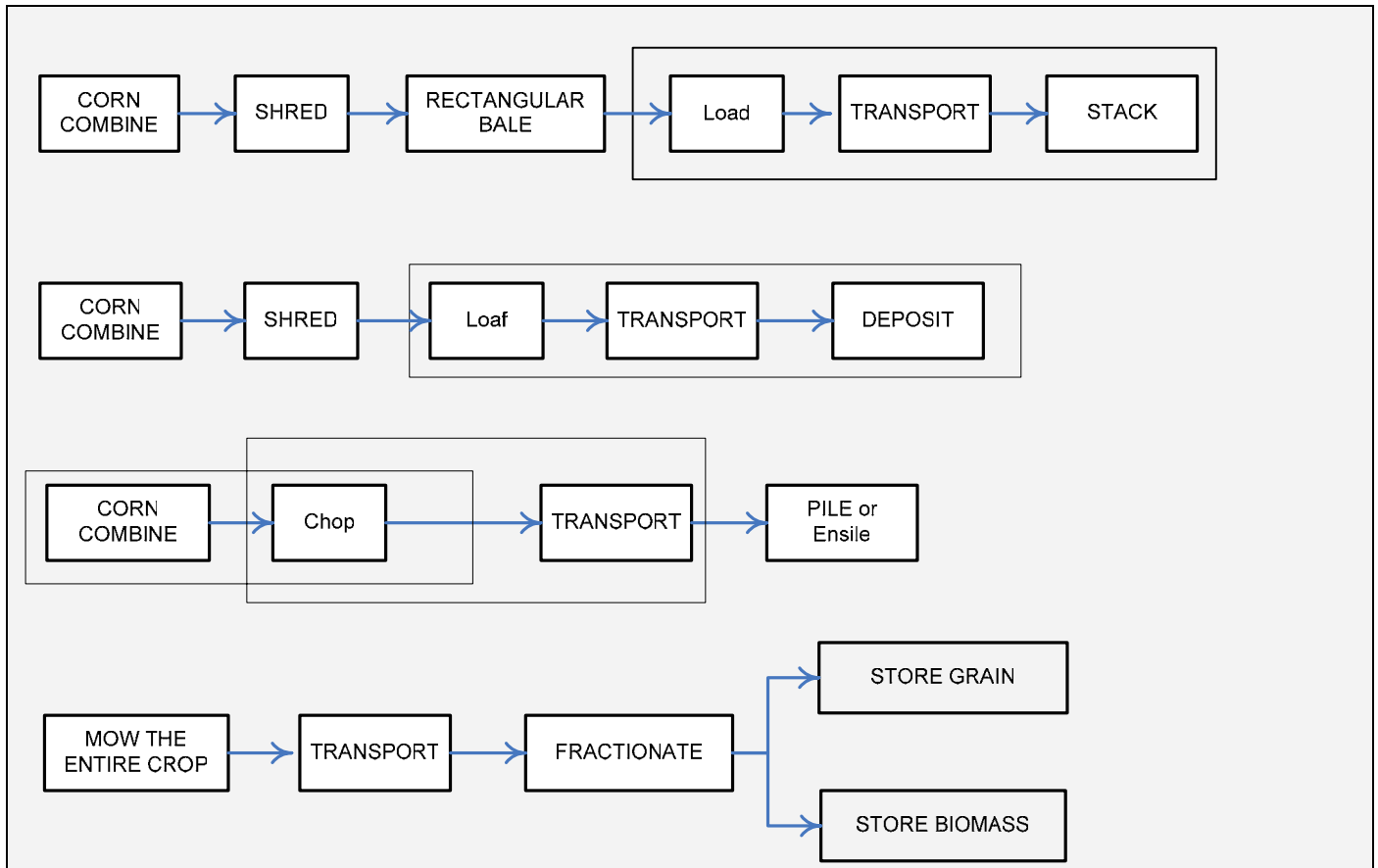

Figure 4. Options for collecting and stacking stover

Figure 5 shows the schematic of a forage macerator. The cutter bar in front of the machine cuts the grass. The reel pushes the material to a conveyor feeding one to pair of ribbed rollers. The rollers draw the material in, pinch and crush the stalks. The mutilated biomass is left in a swath behind the machine to dry for a later collection. Field tests conducted by Pami (1997) showed that the speed of a macerator (Figure 5) is almost the same speed of a normal mower-conditioner at about 6-8 km/h. The power requirement of the mower-conditioner is double of a normal mower (without conditioning rolls).

In the case of late fall harvest; switchgrass is dry even when standing. A mower would be adequate to cut the plant and place it in a swath for immediate baling. No conditioning or maceration is needed. This statement is validated by Venturi et al. (2004) who recommend mowing and conditioning during early season but only mowing late in the season as the moisture content of the plant decreases. But they also found that round baling late in the season is difficult due to the toughness of the straw.

For wheat, cutting is not required as the height of cut can be adjusted during combining. In stripper header combining, standing stalks are cut and windrowed for baling. For most cases straw is of a low moisture content at the time of grain harvest or immediately after grain harvest. Operations to expedite field drying of straw may not be needed.

For corn stover, situation is different. Grain and stalk are at different moisture content during harvest. Figure 6 is a plot of stover moisture content and grain moisture content after the kernel has matured to 40% moisture content (Sokhansanj 2006). Stover moisture content initially at more than 75%

(wb) drops to 10% towards the end of harvest season. Special operations are needed to deal with the variation in moisture content. Shredding the stover and spreading it with the combine accelerates field drying. The spread material then has to be raked into windrows for efficient baling. Many operations use a flail shredder to shred the broken stalks while gather the shredded material in a windrow in a single operation.

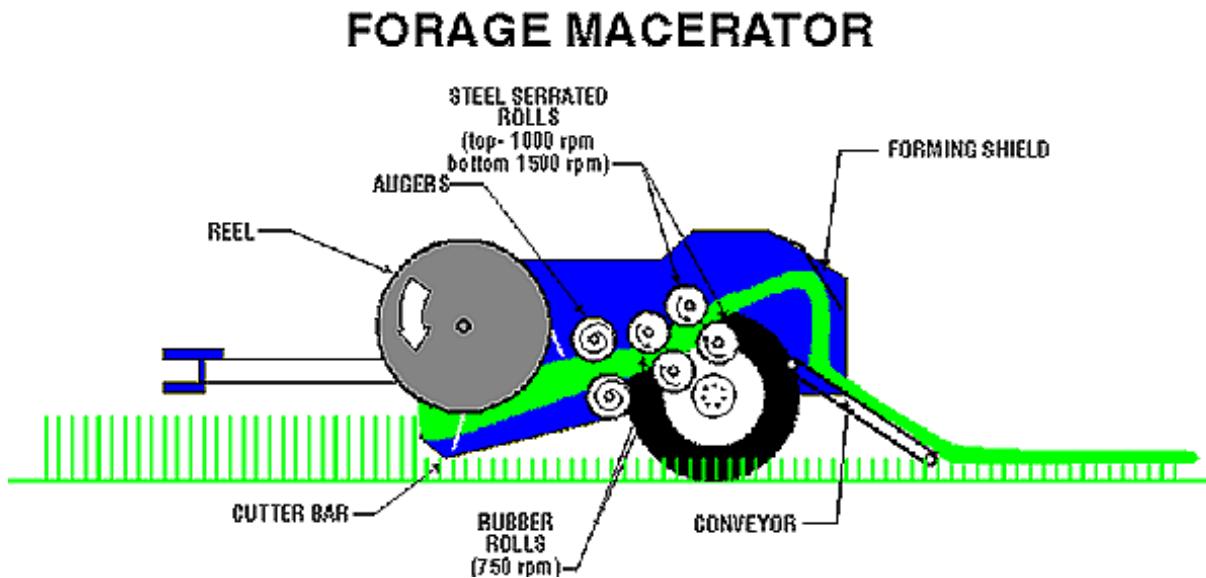

Figure 5. Diagram a macerator used for harvesting and macerating green grasses. The diagram is from the web site: http://www.pami.ca/hay_maceration.htm

3.4 Collection

We define collection as operations for picking up the biomass, packaging, and transporting to a nearby site for temporary storage. The most conventional method for collecting biomass is baling. Bales are in the form of either rounds or squares. Round bales are popular on most U.S. farms (Cundiff 1995; Cundiff 1996; Bransby and Downing 1996; Cundiff and Marsh 1997); Limited experience with using round bales for biomass applications indicates that round bales are not suitable for large scale biomass handling. Because of their round shape, round bales tend to deform under static loads in a stack. Bales that are not perfectly round can not be loaded onto trucks to form a transportable load over open roads. Experience with switchgrass harvest at the Chariton Valley Co-firing project in Iowa (CV-CR&D 2002) showed that variations in the density of round bales were the cause of uneven cuts and erratic machine operation during de-baling process. CV-CR&D (2002), Miles (2006) decided to accept only large square bales.

Baling - Large square bales are made with tractor pulled balers. Large square bales are currently made either in dimensions 1.2 mx1.2mx2.4 m (4'x4'x8') or 0.9mx1.2mx2.4 m (3'x4'x8'). A bale accumulator is pulled behind the baler that collects the bales in group of 4 and leaves them on the field. At a later date when available, an automatic bale collector travels through the field and collects the bales. The automatic bale collector travels to the side of the road and unloads the bales into a stack. If the automatic bale collector is not available bales may be collected using a flat bed truck and a front end bale loader. A loader is needed at the stack yard to unload the truck and stack the bales. The stack is tarped using a forklift and manual labor.

Loafing - Mowing, conditioning, and raking operations are identical to those for baling. When biomass is dry, a loafer picks the biomass from windrow and makes large stacks of about 2.4m wide, up to 6 m long and 3.6 m high (SAF 1979; FMO 1987). The roof of the stacker acts as a press pushing the material down to increase the density of the biomass. Once filled, loafer transports the biomass to storage area

and unloads the stack. The top of the stack gets the dome shape of the stacker roof and thus easily sheds water. The loafer has been used for hay and for corn stover. Loafer is used for corn stover. It was used for experimental wheat straw in Idaho. To the knowledge of the author, the loafer has not been used for switchgrass, so its practical performance is not known at this time.

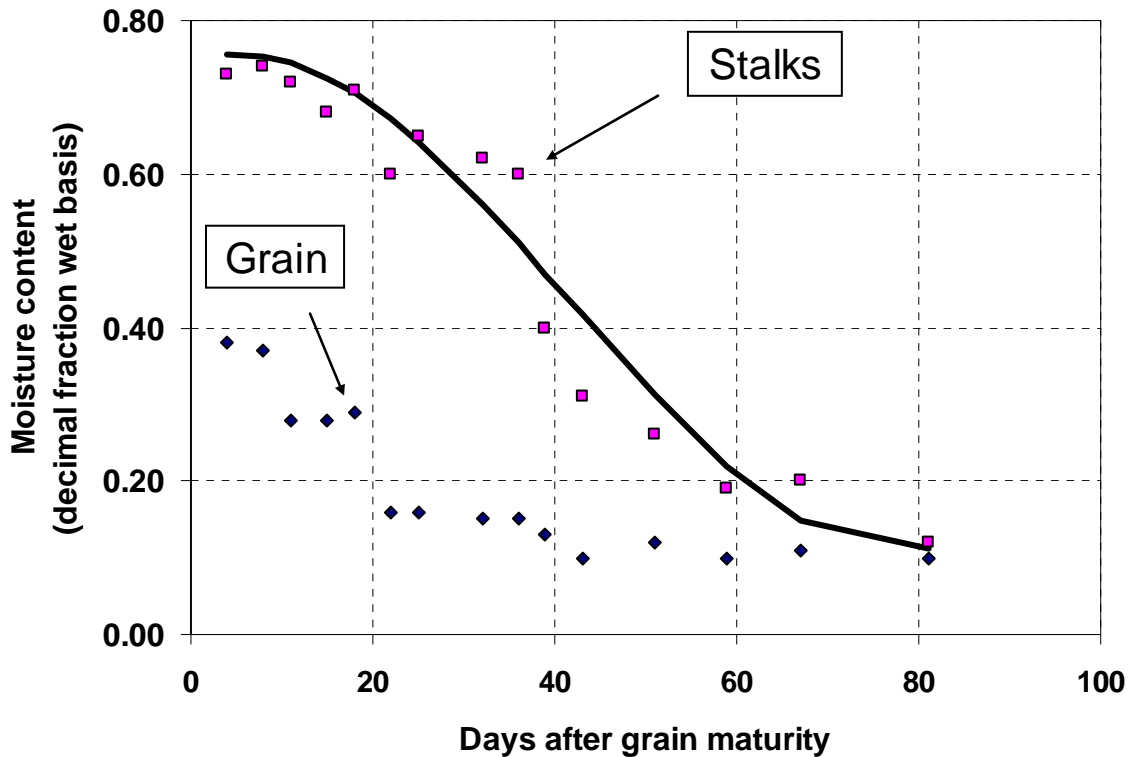

Figure 6: Moisture content of corn stalks (solid line and circles) and of the grain (diamonds) after grain maturity date (Sokhansanj et al. 2006).

Dry chop - In this system a forage harvester picks up the dry biomass from windrow, chops it into smaller pieces (2.5-5.0 cm). The chopped biomass is blown into a forage wagon traveling along side of the forage harvester. Once filled, the forage wagon is pulled to the side of the farm and unloaded. A piler (inclined belt conveyor) is used to pile up the material in the form of a large cone.

Wet chop - In this system a forage harvester picks up the dry or wet biomass from the windrow. The chopped biomass is blown into a forage wagon that travels along side of the harvester. Once filled, the wagon is pulled to a silage pit where biomass is compacted to produce silage (Luginbuhl et al. 2000). For silaging dry corn stover, water is added to create silaging moisture content. To the knowledge of author, research is not available for silaging dry Switchgrass. Work is in progress for silaging corn stalks and wheat straw.

Whole crop harvest - The last rows in flow diagrams in Figures 3 and 4 show harvesting and collecting the entire crop that includes straw and grain in a single operation. The entire material (grain and biomass) is transferred to a central location where the crop is fractionated into grain and biomass. The whole-crop harvesting and fractionation concept has been researched for many years (Buchele 1976). A whole-crop wheat harvester was developed in Sweden in early 1980's (Lucas 1982) at a cost of more than \$5 million. The self-propelled machine was able to harvest the entire crop, thresh and clean the grain and bale the straw, all in one step. Recent efforts (Quick and Tuetken 2001) have been reported to

develop a whole-crop harvester and transported for corn.

The McLeod Harvester (St. George 2000) developed in Canada fractionates the harvested crop into straw and graff (graff is a mixture of grain and chaff). The straw is left on the field. Grain separation from chaff and other impurities take place in a stationary system at the farmyard. The new machine is credited with higher capacity and efficiency than current grain combines. PAMI (1998) conducted an economic analysis to show that whole crop baling resulted in the highest net return among six different systems including McLeod harvester. For the whole crop baling, the crop (wheat) was cut and placed in a windrow for field drying. The entire crop was then baled and transported to the processing yard. The bales were unwrapped and fed through a stationary processor that performed all the functions of a normal combine. The straw was re baled.

4. BIOMASS PREPROCESSING

Loose cut biomass has a low bulk density ranging from 50 to 120 kg/m³ depending on the particle size (Table 4). In case of chopped and ground biomass, the bulk density can be increased substantially (~25%) by vibrating the biomass holder (ex. truck box, container). To increase density, the biomass must be mechanically compacted (Sokhansanj et al. 1999). A densified biomass to briquettes, cubes, and pellets has densities in the range of 300 to 700 kg/m³.

Table 4 Bulk density of biomass

Form of biomass	Shape and size characteristics	Density (kg/m ³)
Chopped biomass	20-40 mm long	60-80
Ground particles	1.5 mm loose fill	120
Ground particles	1.5 mm pack fill with tapping*	200
Briquettes	32 mm diameter x 25 mm thick	350
Cubes	33 mm x 33 mm cross section	400
Pellets	6.24 mm diameter	500-700

* Biomass is spread into the container while tapping the container

Pellets are usually in the form of a hardened biomass cylinder, 4.8 to 19.1 mm in diameter, with a length of 12.7 to 25.4 mm. Pellets are made by extruding ground biomass through round or square cross sectional dies. The unit density of pellets (density of a single pellet) is 960 to 1120 kg/m³. Bulk density of pellets may be as high as 750 kg/m³. Cubes have a lower density than pellets. Typical bulk density of cubes range from 450 kg/m³ to 550 kg/m³ depending upon the size of cubes.

4.1 Operations for dense biomass

Figure 7 shows the flow of biomass (switchgrass in this case) for a densification process. Biomass arrives at the plant in chops or bales. The bales are cut into short pieces using a hydraulic piston pressing the hay against a grid of knives. The bales can also be shredded using a roller and knife arrangement. If the moisture is more than 15%, the chopped biomass is dried in a drum dryer.

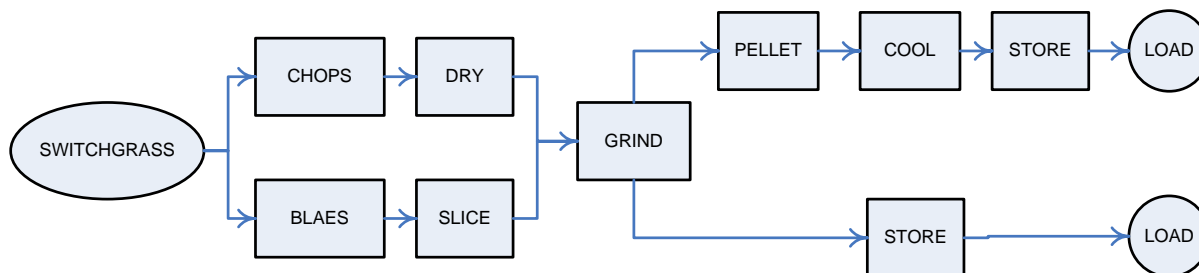

Figure 7. Flow chart for pre processing of biomass to pellets or to small particles. Pelleting is

done when material travels a long distance to biorefinery.

Figure 8 shows the relationship between particle size and bulk density of biomass for an industrial grinder. The spread in data can be attributed possible to variations in actual particle size distribution in various size groups. Note that in this particular example size groups vary from 1 to 3 mm. The bulk density for 2.5 mm is slightly more 100 kg m⁻³. The bulk density is creases to more than 160 kg m⁻³. Table 4 indicates that bulk density can be increased by almost 25% by tapping (vibrating) the container.

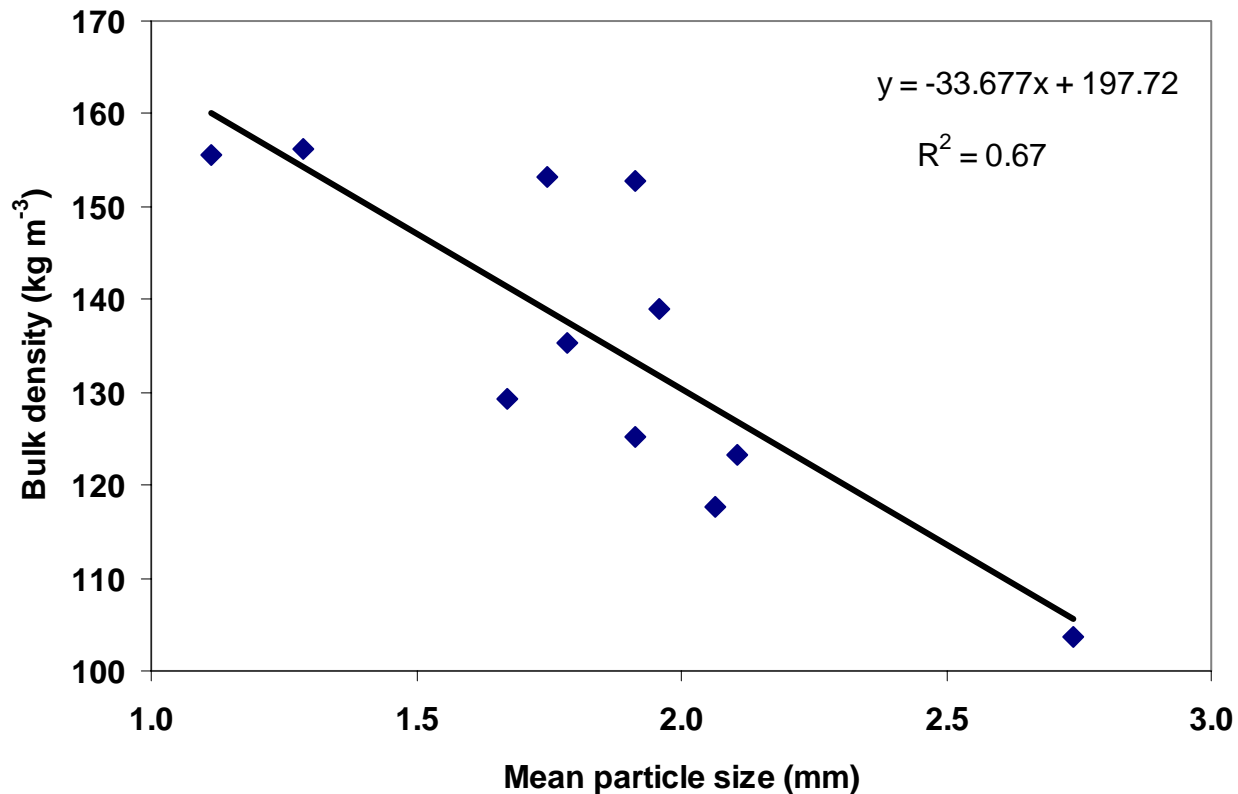

Figure 8. Bulk density vs. mean particle size of biomass

In preparation for pelleting, the dried chops are ground in a hammer mills. For cubing, the chops are not ground. For pelleting the ground biomass is mixed with saturated steam - in a paddle mixer located on top of the mill. Steam heats and moisturizes grind biomass. For cubing, small quantities of water is added to biomass. The steam or water acts as a lubricant to enhance binding. The moisture content of mash before pelleting is usually in 10% range and that of chops before cubing is 12%.

Pellet mills are equipped with a large diameter short screw, a die ring, and from 1 to 3 press rolls. The feed screw pushes the biomass uniformly towards the openings in the die ring. Press wheel forces the feed through the die openings in the ring. The pressures in the mill range from 24 to 34 MPa (Tabil et al. 1997). Pellets and cubes exit the mill warm and moist. They are cooled and dried to a moisture content of roughly 10% for cubes and 8% for pellets. The cooled pellets and cubes are stored under roof in a flat storage or in hopper bottom silo. Pellets and cubes are loaded into rail cars or trucks using a front-end loader or from self unloading overhead bins.

As the flow diagram in Figure 7 (Mani et al. 2006) shows, the preprocessing of biomass may consist only of grinding. The grind will have a bulk density of 180 kg/m³ in the truck box. This density is suitable for short hauls. For longer hauls and long term storage, it is preferred to densify biomass to pellets or cubes.

Dense biomass requires less area and volume for storage and transport than loose biomass. In

In addition to savings in transportation and storage, granulated biomass lends itself to easy and cost effective handling. Dense cubes pellets have the flow ability characteristics similar to those of cereal grains. Bulk handling equipment for granular material is well developed and available commercially (Fasina and Sokhansanj 1996).

5. TRANSPORTATION

Numerous factors influence the size and mode of transportation. A few of these factors that authors believe are most important are listed as follows:

- The maximum rate of biomass supply to biorefinery (t/h)
- Form and bulk density of biomass (t/m³)
- The distance biomass has to travel to reach to biorefinery (km)
- Transportation infrastructure available between the points of biomass dispatch and biorefinery.

5.1 Transport equipment

For transportation we are primarily concerned with loading and unloading operation and transferring biomass from preprocessing sites to biorefinery. Figure 9 depicts a variety of transport modes. The above factors determine which one of these modes or a combination of will suite the particular biorefinery. Truck transport and for a few cases train transport may be the only modes of transport. But Barge and pipeline transport and often train transport involve truck transport. Trucks interface with trains at loading and unloading facilities of a depot or processing facility. Barge and pipeline require interfacing with train and/or truck transport at major facilities either on land or at the shores

Physical form and quality of biomass has the greatest influence on the selection of equipment for the lowest delivered cost possible. In many transport instances, the rates are fixed for a distance and for a size of container independent of mass to be transported. A higher bulk density will allow more mass of material to be transported per unit distance. Truck transport is generally well developed, is usually cheapest mode of transport but it becomes expensive as travel distance increases. Pipeline transport is the least known technology and may prove to be the cheapest and safest mode of transport – perhaps in a longer term vision 50 years.

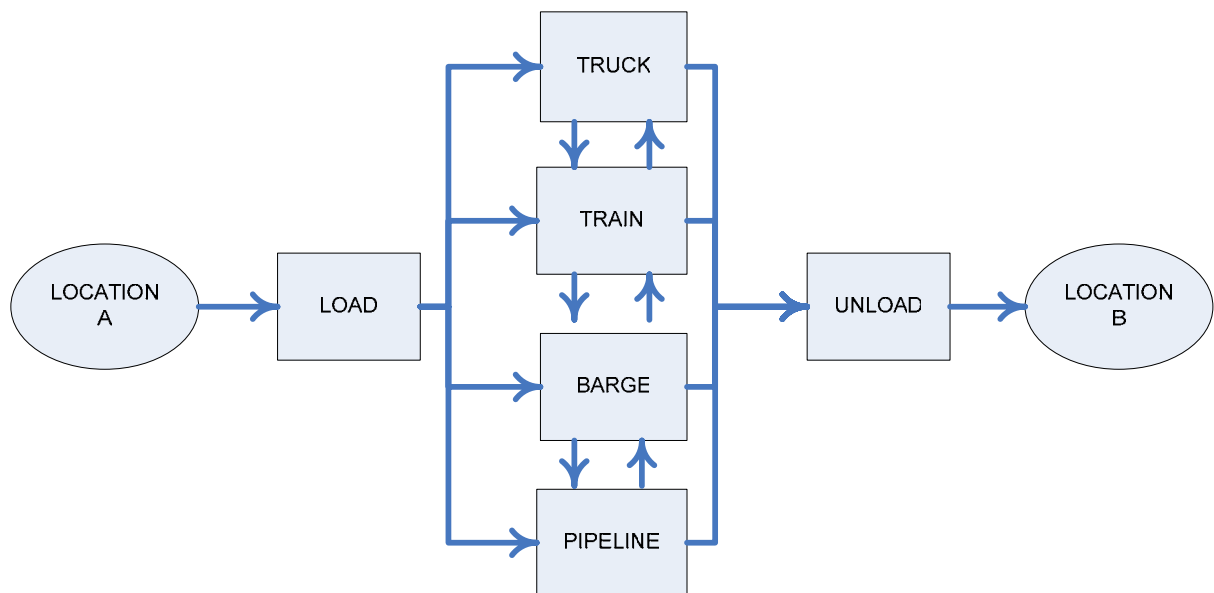

Figure 9. Transporting biomass from location A to location B. Various of modes of transport are depicted here. There may be one or a combination of more one transport modes are involved.

Biomass is transported by pipeline in the form of a slurry mixture; the carrier fluid is water. Upstream equipment includes receiving, slurry making, and initial pumping. The elements along the pipeline are the booster pumps and at the end the equipment are for draining of the biomass from the carrier liquid Kumar et al. (2005). Unlike truck and train transport there is an economy of scale for pipeline transport. A larger diameter pipe has a lower friction and thus lower pumping cost.

5.2 Logistics

Logistics of biomass supply involves an orderly flow of biomass from farm to factory. Figure 10 shows at least 5 options for the supply chain configurations. Options 1 and 2 the packaged biomass is transported directly from farm or from stacks next to the farm to biorefinery. Biomass may be minimally processed (i.e. ground) before being shipped to the plant. In this case the biomass is generally supplied from the stacks where the biomass will be minimally processed. Generally the biomass is trucked directly from farm to biorefinery if no processing is involved.

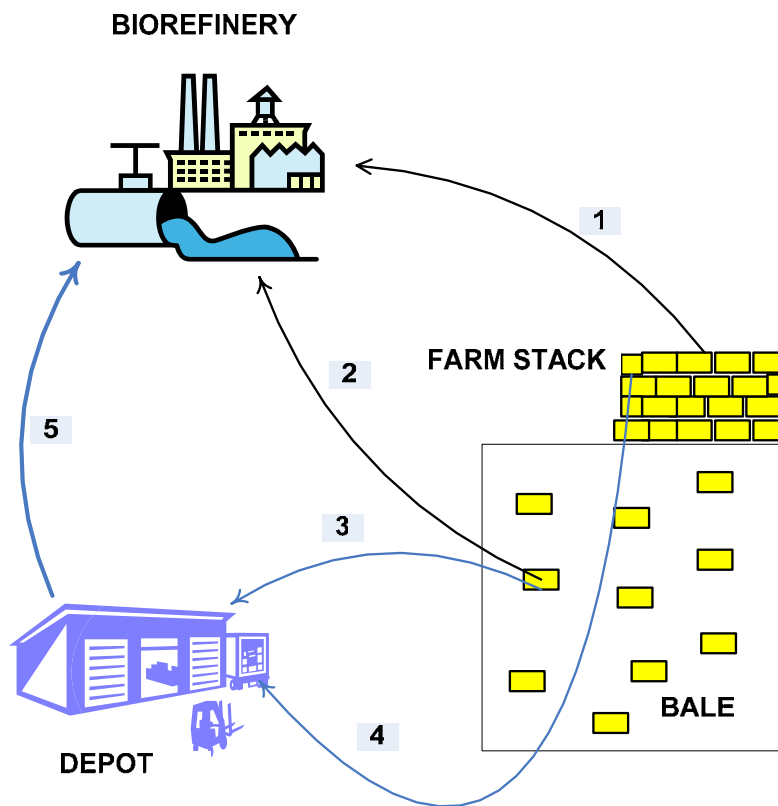

Figure 10. Logistics of supplying biomass to a biorefinery.

The supply options 3 and 4 transfer the biomass to a central location where the material is cumulated and is dispatched to biorefinery later on. While in depot, the biomass could be pre processed minimally (i.e. ground) or extensively (pelletized). The depot also provides an opportunity to interface with rail transport if that is an available option. The choice of any of the options 1 to 5 depends on the economics and cultural practices. For example in irrigated areas, there is always space on the farm (corner of the land where quantities of biomass can be stacked). In northern dry land farming, the farmer may allow storage of biomass on the field over winter until April but needs to land to see for new crop.

6. COSTS

The Integrated Biomass Supply Analysis and Logistics (IBSAL) model was used to calculate cost and energy inputs for the supply chain of biomass (Sokhansanj 2006). IBSAL consists of different sub-modules for harvesting, processing, pre processing (grinding), storage and transportation. Model input data include: local weather data; average net yield of biomass; crop harvest progress data (including start and end dates of harvest); dry matter loss with time in storage; moisture content of plant at the time of harvest; operating parameters of equipment; and \$/h cost of machinery. The model is built on the EXTEND™ platform. (www.imaginetthatinc.com). Main outputs of the model include: delivered cost of biomass (\$/t); carbon emission (kg of C per t) and energy consumption (GJ/t). IBSAL also calculates dry matter losses of biomass using limited data available for storing switchgrass bales (Sanderson et al. 1997) and handling hay (Rees, 1982). Details of the model can be found in Sokhansanj (2006) and Sokhansanj et al. (2006). Figure 11 shows the outline of the IBSAL including input data and its output.

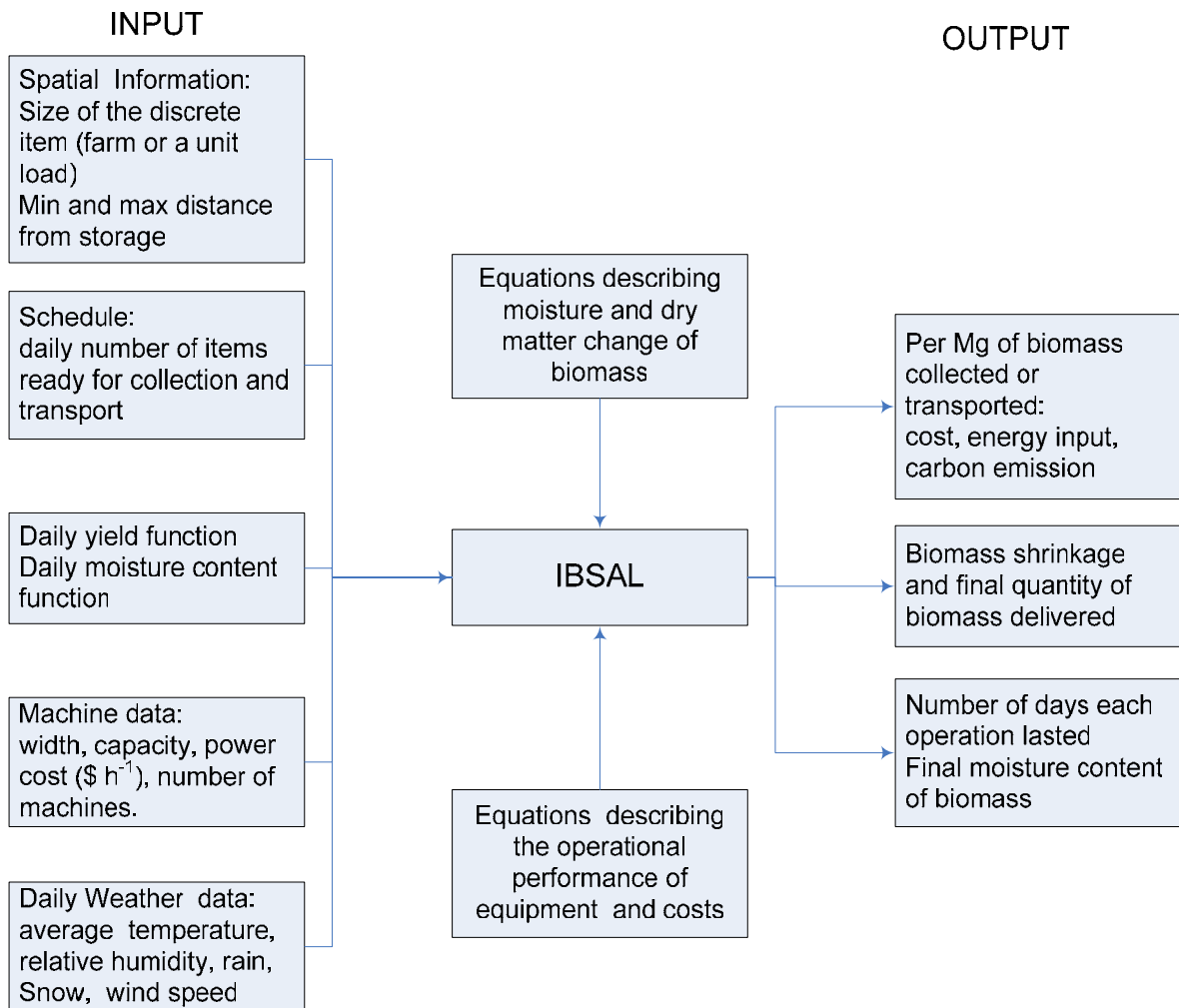

Figure 11: Overall structure of IBSAL collection modules defining input and output.

Table A1 in appendix A lists field equipment and their specifications that are used for collection and transport of switchgrass. The choice of particular size and operating conditions are based on three objectives: (1) the latest model of equipment that are commercially available for forage harvest, (2) the typical operational performance data that are available given by the ASAE D497 (ASAE, 2004) or from

manufacturer's literature, and (3) limited equipment performance data published for switchgrass elsewhere.

Table A1 also lists machinery costs in \$/h. These hourly costs are calculated using the procedure and data described in Sokhansanj and Turhollow (2002). The rates represent the sum of fixed and variable costs. The hourly rates for the pull-type equipment (ex. baler) are the sum of the hourly rate for the implement and the power equipment (ex. tractor).

Collection option analyzed was baling, loafing, dry chop harvest and piling, and wet chop harvest and silaging. We assumed bale and loafs are stacked next to the farm. Likewise the piles of dry chops and silage pit are also located nearby. We assumed the farm in the shape of a square with each side 1.6 km (1 mile). A winding factor of 1.2 was assumed between the collection point and the stacking yard.

Figure 12 shows collection and arrangement for two Sections of land (each section is roughly 260 ha or 640 acres). Each Section consists of four Quarter Sections. The grid roads and access to each Quarter Section are identified. The stacks of collected biomass are placed along the road for pick up and transport either to biorefinery or a pre processing depot site.

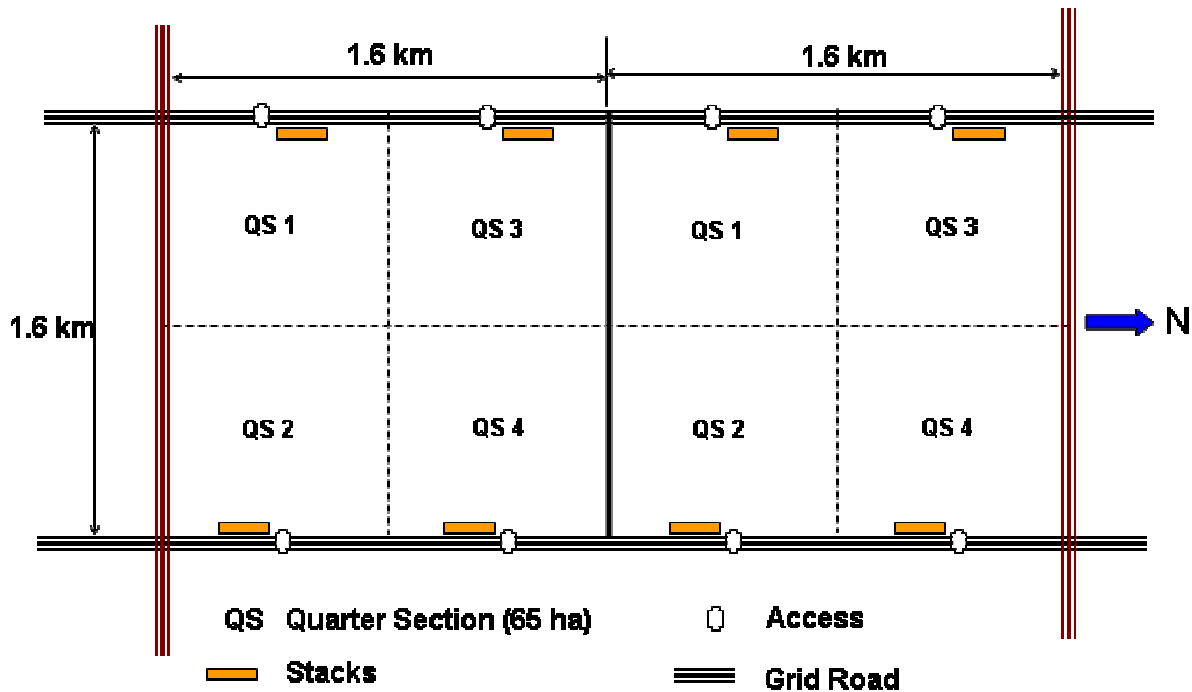

Figure 12. logistics of biomass collection and temporary storage on a typical size farms in mid-west (U.S. and Canada)

6.1 Collection costs

Table 5 summarizes the simulation results for collecting switchgrass. Similar data can be developed for collecting wheat straw and stover and other crop residue. Square baling cost is the highest at 23.72 \$ t⁻¹ (followed by loafing at 19.21 \$ t⁻¹). The low collection cost using loafer is due to its reduced number of operations and the size of the loaf. The higher cost for dry chopping and piling (35.17 \$ t⁻¹) and for ensiling (35.75 \$ t⁻¹) is due to the higher cost of the forage chopper. Mowing and raking operations are eliminated in silaging operation but the extra cost of silage pit and packing the silage offsets the lower cost of harvest. The input data for silaging also includes the cost of silage pit at \$4757 per year.

Table 5 also lists energy inputs for the collection options. The energy inputs range from 0.319 GJ/dry t for loafing to 0.590 for the dry chop system. The energy inputs are dependent on the size of power used to operate the equipment. Forage choppers require large amounts of power – more than 200 kW (see table A1). Using 16 GJ/dry t as the energy content of dry switchgrass, the energy input to the

system ranges from roughly 2% for loafing to less than 4% for dry chopping. The energy expenditure for silaging is slightly less than for dry chopping. Coronado et al. (2005) analyzed switchgrass collection and handling with various equipment and concluded that once optimized for switchgrass loafing can become the most cost-effective option.

Table 5. Cost, energy and emission components for each unit operation in biomass collection .

Collection options	Collection cost (\$ t⁻¹)	Energy consumption (GJ t⁻¹)	Carbon emission (kg t⁻¹)
Square bales			
Mow	4.02	0.053	4.1
Rake	1.94	0.030	2.4
Bale (large squares)	9.66	0.133	10.4
Roadsiding and stacking	4.54	0.083	6.5
Tarping	1.56	0.012	0.9
Overall	23.72	0.339	26.5
Loafing			
Mow	4.02	0.053	4.1
Raking	1.84	0.029	2.2
Loafing	13.15	0.227	17.8
Overall	19.69	0.319	24.9
Chopping dry – Piling			
Mow	4.02	0.053	4.1
Rake	1.94	0.030	2.4
Harvest	22.14	0.398	31.1
Pile	1.74	0.013	1.0
Overall	35.71	0.592	46.3
Chopping moist – Ensiling			
Harvest	22.48	0.399	8.5
Ensiling	12.58	0.071	1.5
Overall	35.12	0.470	10.0

* - Note that collection costs and other variable do not vary with capacity of the biorefinery.

The collection costs for straw and stover are similar to those in Table 5 for switchgrass. The slight difference (1-2 \$ t⁻¹) difference might be due to an assumed bulk density for each crop or in the cost of shredded used in collecting stover vs. the mower used in collecting switchgrass.

6.2 Transport costs

Transport costs in IBSAL are calculated based upon specifying either a fixed distance or a variable distance. Fixed distance is the transport cost from a particular satellite storage (or stacks) to the biorefinery (Figure 13). For example 5000 t of biomass is transported from Satellite (or depot) A to biorefinery. The variable distance scenario is when we specify a total quantity of biomass to be collected from locations within a specified radius (or a minimum to maximum distance). For example 5000 t (or any quantity) of biomass to be supplied to a biorefinery from within the circle. The biomass is

supplied from locations A (maximum distance) or B or C.

IBSAL Analysis of Transport costs - Table 6 shows the cost of transporting baled biomass a variable distance of 20 to 100 km. The cost of transporting biomass for a fixed distance is also calculated. In using IBSAL for transport analysis, the large square bales are loaded on a flat bed (36 bales), the bales are transported to the biorefinery where they are stacked. The bales are ground for entering the process line at the biorefinery. Table 6 shows that cost of transporting a maximum fixed distance is higher than the cost of transporting a variable distance between P and A.

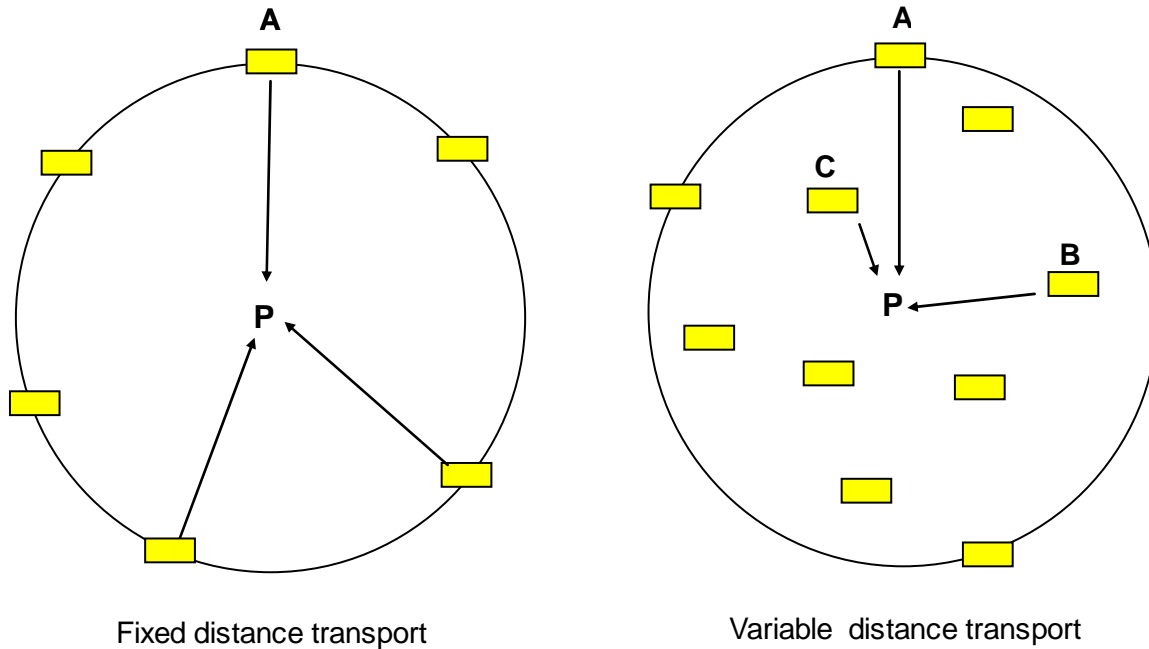

Figure 13. Fixed and variable distance transport

Table 6. Cost, energy, and emissions for each unit operation in transporting bales for a variable distance of between 20 and 100 km and a fixed distance of 100 km.

Transport operations	Transport cost (\$ t ⁻¹)	Energy consumption (GJ t ⁻¹)	Carbon emission (kg t ⁻¹)
Load	2.23	0.094	7.4
Travel ¹	10.11	0.471	20.1
	16.53	0.791	33.8
Unload	1.06	0.208	16.2
Stack	0.36	0.006	0.5
Grind	5.65	0.096	7.5
Overall ¹	19.41	0.875	51.7
	25.83	1.195	65.4

¹ The first row fro travel is for variable distance, the second row is for fixed distance.

form of grind and pellets. Our experiments with the bulk density of grind size of 2.5 mm shows that a bulk density of 120 to 180 kg m⁻³ can be achieved depending on method of fill and the vibration of the container. We assumed a bulk density of 140 . Pellets can have a density as high as 650 kg m⁻³ . We assume a bulk density of 580 kg m⁻³. Table 7 shows that the grind transport cost is also much depends on method of loading. In this analysis we use a front end loader to load the 100 m³ capacity truck. It is costly at 9.03 \$ t⁻¹. Pellets loaded using the same method but cost only 2.71 \$ t⁻¹ due to high bulk density. The total cost of biomass transport or pellets for 20-100 km distance is roughly 6 \$ t⁻¹.

Table 7. Cost, energy, and emissions for each unit operation in transporting grind and pellets for a variable distance of between 20 and 100 km.

Transport operations	Grind transport			Pellet transport		
	cost (\$ t ⁻¹)	Energy input (GJ t ⁻¹)	Carbon emission (kg t ⁻¹)	Cost (\$ t ⁻¹)	Energy input (GJ t ⁻¹)	Carbon emission (kg t ⁻¹)
Load	9.03	0.395	30.5	2.71	0.118	9.3
Transport	11.51	0.522	40.5	3.27	0.149	11.6
Unload	0.31	0.014	1.1	0.09	0.004	0.3
Total	20.85	0.931	72.1	6.06	0.271	21.2

Traditional method of transport analysis - The traditional way of handling biomass transport cost is to consider a constant cost component and a variable cost component for the transport equipment. For truck transport, the constant cost component is the cost of loading and unloading. The variable cost component is the “per km and per t” cost of trucking, accounting for fuel, depreciation, maintenance and labor. The constant cost in case of rail transport includes the capital cost of rail siding, rail cars and equipment for loading and unloading biomass. The variable cost includes the charges of the rail company that include capital recovery and maintenance for track and engines and fuel and operating costs. Table 8 summarizes the cost of transporting biomass using three modes of transport: truck, rail and pipeline. The cost equation for pipeline is developed based on data of Kumar et al. (2004).

Table 8. Cost and energy consumption equations for transporting biomass using truck, rail, or pipeline*

Transport mode	Cost (\$ t ⁻¹)	Energy consumption (MJ t ⁻¹)
Truck	5.70+0.1367 L	1.3 L
Rail	17.10+0.0277 L	0.68 L
Pipeline*	2.67Q ^{-0.87} +0.37LQ ^{-0.44}	160.2Q ^{-0.87} +22.2 LQ ^{-0.44}

L distance (km)

Q annual supply (million dry t)

* the cost and energy values for pipe line are in \$ and in MJ

Figure 14 compares the cost of transporting biomass using three modes of transport. For pipeline the annual capacity is assumed 1 million dry t. In this model, the transport cost in \$ t⁻¹ for truck and rail does not change with capacity (in real situation the size of contracts with transport companies affect the prices). Pipeline has the steepest cost curve because of the increased capital cost with distance.

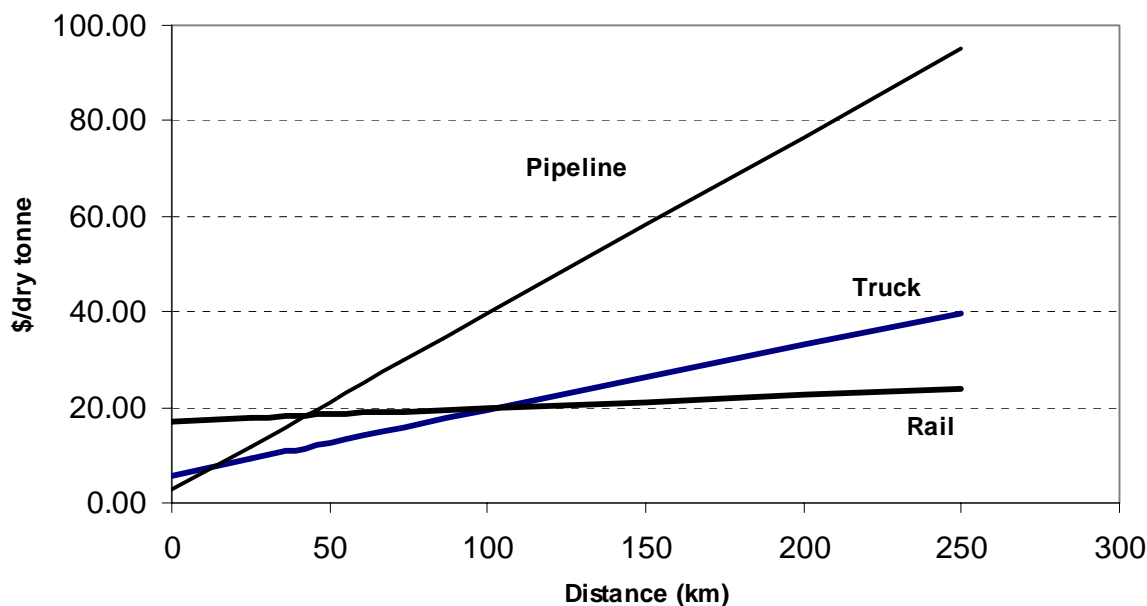

Figure 14. Transport cost of switchgrass using three modes of transport. For pipeline an annual capacity of 1 million t is assumed.

Truck and rail costs intersect at about 110 km for the cost figures used in this analysis. It should be mentioned that the cost structures for rail are much more complicated than what is given in this analysis. In cases where a multi mode transport is required the cost structures will be a blend of two or three of these modes. At this point we would like to caution against over generalization of equations in Table 5 and graphs in Fig. 8. The cost of trucking, rail, and even pipeline much depends upon available infrastructure, custom rates, road travel regulations and size of contracts.

Table 8 lists estimates for energy consumption by truck, rail, and pipeline. The energy input for truck and for rail is 1.3 and $0.68 \text{ MJ t}^{-1} \text{ km}^{-1}$, respectively (Borjesson, 1996; Kumar et al. 2006). The energy input for rail transport is $0.68 \text{ MJ t}^{-1} \text{ km}^{-1}$. It is assumed that diesel fuel is used for both truck and rail. The electrical power is assumed to be produced from a coal power plant; we assumed an electricity price of $\$0.06 \text{ kWh}^{-1}$ to convert from the cost (\$) to energy (MJ) consumption for the pipeline.

6.3 Granulation costs

Our granulation (densification) process in this paper is pelletization of biomass. The base case pellet plant has a production capacity of 6 t/h with the annual production of 45,000 t (Mani et al. 2006). The plant operates 24 h for 310 days annually (annual utilization period 85%). Table 9 summarizes the cost of pellet production including variable costs using the system in Figure C1 (Appendix C). For the base case, wood shavings at 10% (wb) moisture content was considered as a burner fuel with a fuel cost of $40 \text{ \$ t}^{-1}$ delivered to the pelleting plant. Cost of wood shavings is considerably high due to the high demand for animal bedding materials and as a fuel for the pulp mills. The capital and operating cost of producing biomass pellets are 5.64 and $25.18 \text{ \$ t}^{-1}$ of pellet production, respectively. The cost of producing pellets ($30.83 \text{ \$ t}^{-1}$) may be further reduced if the plant capacity is increased. Sokhansanj and Turhollow (2004) calculated a cost for cubing of corn stover at $26.17 \text{ \$ t}^{-1}$ using corn stover as source of heat in the biomass dryer.

Table 9 lists energy inputs to produce pellets. A sum of 0.821 GJ t^{-1} is calculated for the entire process. The sum is roughly 5% of the 16 GJ energy content in a t of dry switchgrass. The most energy consuming operation is the dryer (assumed drying from 50% to 10%) which constitute more than 40% of the entire energy used for pelleting. Next in the list is the pelleting process followed by the grinder.

There are a number of means of lowering pellet costs and energy consumption. It is possible to move the grinding operation to the field and grind to a bulk density as high as 128 kg m^{-3} . This change in the

process sequence would reduce the cost of transporting loose stover and give almost the same density as a bale without the baling cost. Costs might be lowered by as much as 10 \$ t⁻¹. Operating the pelleting facility 300 days instead of 240 days/year will reduce costs. Achieving a higher density cube and higher pellet mill throughput, as with alfalfa, would also contribute to lowering costs. Other additional opportunities to reduce costs would include having multiple feedstocks that are available as a fresh supply for as much as 180 to 240 days of the year.

Table 9. Cost of biomass pellet production for the base case (2004 US dollars)

Pellet process operations	Capital cost (\$ t ⁻¹)	Operating cost (\$ t ⁻¹)	Total cost (\$ t ⁻¹)	Energy use (GJ t ⁻¹)
Drying operation	2.46	7.84	10.30	0.350
Hammer mill	0.25	0.70	0.95	0.100
Pellet mill	1.43	1.88	3.31	0.268
Pellet cooler	0.13	0.21	0.34	0.013
Screening	0.11	0.05	0.16	0.006
Packing	0.56	1.37	1.93	0.006
Pellet Storage	0.07	0.01	0.08	0.026
Miscellaneous equipment	0.42	0.33	0.76	0.052
personnel cost	0.00	12.74	12.74	-
land use & building	0.21	0.05	0.26	-
Total cost ¹	5.64	25.18	30.83	0.821
	3.18	17.34	20.53	0.471

¹First row of total cost includes drying. Second row of total cost does not include drying

7. CONCLUDING REMARKS

In this paper we analyzed the state of the art of the existing technologies for supply of biomass to a biorefinery. We focused on crop residue (stover and straw) and a dedicated energy crop (switchgrass). We also presented scenarios for potential technologies that will reduce the cost of supply. The analysis shows that the followings are key components to reduce costs:

- Reduce the number of passes through the field by amalgamating collection operations.
- Increase the bulk density of biomass
- Work with reduced moisture content.
- Granulation/pelletization is a viable option though the existing technology of granulation is expensive.
- Trucking seems to be the most prevailing transport option but other modes of transport such as rail and pipeline may become attractive once the capital costs for these transport modes are reduced.

Biorefinery requires biomass in a form that could yield the maximum conversion products. Among desirable specification is cleanliness of the biomass – to be free from dirt, stone, synthetic fibers, and oil. It is also desirable to have biomass at a uniform moisture content and particle size distribution. Further physical and chemical specifications will become important as conversion technologies advance. Biomass also has to be preprocessed to increase its bulk density and its flowability. A densely granulated biomass takes much less space than a bulky fibrous biomass. The dense granulated biomass can also flow easily. Biomass can be engineered to meet both the requirement of biorefinery as well as its low cost safe handling issues.

Table 10 lists the minimum and maximum costs involved in biomass collection, pre processing (pelleting)

and transport. The delivered cost varies from a minimum of 46 \$ t⁻¹ to more than 78 \$ t⁻¹. This cost does not include payment to farmer which might be around 10 \$ t⁻¹. The total energy input to the system ranges from a low of 1 to 1.5 GJ t⁻¹. This amount of energy input is roughly from 6 to 10% of the total energy content of biomass (estimated at 16 GJ t⁻¹)

Table 10. Minimum and maximum cost of biomass supply (20 to 100 km distance) including granulation (pelleting)

Operations	Low		High	
	Cost (\$ t ⁻¹)	Energy (GJ t ⁻¹)	Cost (\$ t ⁻¹)	Energy (GJ t ⁻¹)
Collection	19.69 ^a	0.319	23.72 ^b	0.339
Transport	6.06 ^c	0.271	23.72 ^d	0.339
Granulation (pellet)	20.53 ^e	0.471	30.85 ^f	0.821
Granulation (grind)	5.65	0.096	5.65	0.096
Total	46.28	1.006	78.29	1.509

^a loafing; ^b baling; ^c transport pellets, ^d transport grind, ^e no drying, ^f with drying,

8. REFERENCES

- ASAE. 2004. Standard 48th Edition. ASAE D497. American Society of Agricultural Engineers, St. Joseph, MI.
- Borjesson, P.I.I. 1996. Emissions of CO₂ from biomass production and transportation in agriculture and forestry. *Energy Conversion Management*, 37(6-8):1235-1240.
- Bransby, D.I., M. Downing. 1996. Yield effects on bale density and time required for commercial harvesting and baling of switchgrass. *Proc., BIOENERGY '96 - The Seventh National Bioenergy Conference: Partnerships to Develop and Apply Biomass Technologies*, September 15-20, 1996, Nashville, Tennessee.
- Buchele, W.F. 1976. Research in developing more efficient harvesting machinery and utilization of crop residue. *Transactions of the ASAE* 19:809-811.
- Conrado, R., K. Linden, R. Martin and A. Pinge. 2005. Switchgrass feedstock logistics systems. ENGS 190/290 Final Report, Winter 2005, Report number – 27, Thayer School of Engineering at Dartmouth College, 8000 Cummings Hall, Hanover, NH 03755-8000.
- Cundiff, J.S., L.S. Marsh. 1996. Harvest and storage costs for bales of switchgrass in the southern United States. *Bioresource Technology* 56(1996):95-101.
- Cundiff, J.S. 1995. Delayed harvest of switchgrass. 1994-1995 Annual Report. Biological Systems Engineering Department. Virginia Tech. Blacksburg, VA 24061-0303. 16 pages.
- Cundiff, J.S. 1996. Simulation of five large round bale harvesting systems for biomass. *Bioresource Technology* 56(1996):77-82.
- Cundiff, J.S., and H. Shapouri. 1997. Cost and direct energy input to produce, fuel pellets from switchgrass. An ASAE Meeting Presentation paper 976078. St. Joseph, MI 49085-9659: ASAE 32 pages.
- Cundiff, J.S., R. Grisso, P.P. Ravula. 2004. Management system for biomass delivery at a conversion plant. An ASAE/CSAE Meeting Presentation paper 046169. St. Joseph, MI 49085-9659: ASAE 29 pages.
- CV-RC&D. 2002. Chariton Valley Biomass Project Design Package. Prepared for USDOE under Contract #DE-FC36-96 G010148. Chariton Valley RC&D Centerville, Iowa, USA.
- Fasina, O.O. and S. Sokhansanj. 1996. Storage and handling characteristics of alfalfa pellets. *Powder Handling and Processing* 8(4):361-365.
- FMO. 1987. Hay and forage harvesting. Fundamental of machine operation. Deere and Company. Moline, IL 61265. 150 pages.

- Kumar A., Cameron J.B., and Flynn P.C., 2004. Pipeline Transport of Biomass, *Applied Biochemistry and Biotechnology* 113(1-3), 027-040.
- Kumar A., Cameron J.B., and Flynn P.C. 2005. Pipeline Transport and Simultaneous Saccharification of Corn Stover, *Bioresource Technology* 96 (7), 819-829.
- Kumar, A., S. Sokhansanj and P. C. Flynn. 2006. Development of a Multi-Criteria Assessment Model for Ranking Biomass Feedstock Collection and Transportation Systems. Accepted for publication in *Proceedings of the 27th Symposium on Biotechnology for Fuels and Chemicals*
- Lucas, J. 1982. Whole crop harvesting - 300 horsepower harvester. *Power farming* 62(12):12-15.
- Luginbuhl, J.M., K. R. Pond, J. C. Burns, and D. S. Fisher. 2000. Intake and chewing behavior of steers consuming switchgrass preserved as hay or silage. *Journal of Animal Science* 78:1983-1989.
- Mani, S., S. Sokhansanj, X. Bi, A. Turhollow. 2006. Economics of Producing Fuel Pellets from Biomass. *Applied Engineering in Agriculture* (under review).
- Miles, T.R. 2006. Personal communication. Miles Engineering, Oregon.
- PAMI. 1997. Hay in a day. Preliminary results of PAMI's hay macerator project. PAMI Research Report # 715. Prairie Agricultural Machinery Institute, Humboldt, Saskatchewan, Canada (www.pami.ca)
- PAMI. 1998. Modeling and comparing whole crop harvest systems. Research update No. 739. Prairie Agricultural Machinery Institute, Humboldt Saskatchewan, Canada. 8 pages.
- Quick, R.G. and T.J. Tuetken. 2001. Harvest, handling, and densification for commercial processing of biomass feedstock. DOE/EE/10595-4. Iowa State University, Ames, Iowa, 5 pages.
- Rees, D. V. H. 1982. A discussion of the sources of dry matter loss during the process of haymaking. *Journal of Agricultural Engineering Research* 27:469-479.
- St. George, D.R. 2000. The McLeod Harvest System and ethanol production. Prepared for Corn Stover Harvest Meeting, Iowa Energy Center, Nevada, Iowa. 10 pages. (D.R. St. George, Manitoba Hydro, Winnipeg, Manitoba (e-mail drstgeorge@hydro.mb.ca).
- SAF. 1979. Forage harvesting methods. Publication 5M/3/79. Saskatchewan Agriculture, Regina, Canada S4P 3V7. 23 pages.
- Sanderson M. A., R. P. Egg and A. E. Wiselogel. 1997. Biomass losses during harvest and storage of switchgrass. *Biomass and Bioenergy* 12(2):107-114.
- Sokhansanj, S. and A. F. Turhollow. 2002. Baseline Cost for Corn Stover Collection. *Applied Engineering in Agriculture* 18(5):525-530.
- Sokhansanj, S., L. Tabil, Jr., and W. Yang. 1999. Characteristics of plant tissue to form pellets. Powder handling and Processing. *The International Journal of Storing, Handling, and Processing Powder*. 11(12):149-159.
- Sokhansanj, S. and A. Turhollow. 2004. Biomass densification – cubing operations and costs. *Applied Engineering in Agriculture* 20(4): 495-499.
- Sokhansanj, S. 2006. Overview of the Integrated Biomass Supply Analysis & Logistics (IBSAL). 2006. A special publication Oak Ridge National Laboratory. ORNL/TM-2005/?. 38 pages.
- Sokhansanj, s., A. Kumar, A. Turhollow. 2006. Development and Implementation of Integrated Biomass Supply Analysis & Logistics Model (IBSAL). Submitted to *Biomass and Bioenergy*.
- Tabil, L., S. Sokhansanj, and R.T. Tyler. 1997. Performance of different binders during alfalfa pelleting. *Canadian Agricultural Engineering* 39(1):17-23.
- Venturi, P., A. Monti, I. Piani, G. Venturi. 2004. Evaluation of harvesting and post harvesting techniques for energy destination of switchgrass. *Proceedings of the 2nd Conference on Biomass for Energy, Industry, and Climate Protection*, 10-14 May 2004, Rome. Editors: W.P.M. Van Swaij et al. Pages 234-236.
- Vogel, P.K., J.J. Brejda, D.T. Walters, and D.R. Buxton. 2002. Switchgrass biomass production in the Midwest USA: harvest and nitrogen management. *Agronomy Journal* 94:413-420.

APPENDIX A

Table A1. Equipment size and specification used in the model to calculate costs and energy input for harvest, collection, and transport (truck).

Equipment	Power (kW)	Vol. (m ³)	Work-ing width (m)	Spee d empty km/h	Speed full km/h	Efficie -ncy	Through -put (dt/h)	Load time (min)	Unload time (min)	Density (kg/m ³)	\$/h
Baler Square	133	3.6	4.27			0.75	14			160	83.66
Forage Harvester (SP)	207		4.27			0.70	16				83.37
Grinder (self-powered)	207					0.85	20				106.13
Loader Bale	89					0.85		0.75	0.5		44.92
Loader Bulk	89	2.8						0.3	0.25	64	44.92
Loafer	118	45.3	4.27	17.6	9	0.65	18		7	80	59.34
Rake	59		4.27			0.8	25			0	32.92
Flat Bed Truck	259			32	15	0.85				160	48.40
Truck Bulk (Silage)	259	135.9		64	35	0.85			8	128	49.57
Stinger	259	0.0		48	25	0.85		0.25	0.25	0	121.96
Wagon Bulk	89	34.0		19.2	10	0.90			3	48	49.46
Forklift for Tarping	44					0.90					44.92
Piler	30					0.90	25				35.76
Silage Compactor	89	2.83				0.90					44.92
Mower - conditioner	89	0.00	4.27			0.80	20				58.40

Appendix B

Estimating supply area

Trucks transport biomass from the farm edge or from an intermediate storage to the biorefinery. The simulated time delay for transportation depends upon the distance of storage to biorefinery plus loading and unloading times. Actual road network and local regulations on maximum load size and allowable maximum speed will determine the delay time affecting the efficiency of road transport.

To develop an initial truck transport model in the absence of actual geographical information, we assumed a biorefinery is located at P (Figure B-1). Several satellite stores S_j supply biomass to the biorefinery P. Figure B-1 shows one of the satellite stores that receives biomass from the area within the circle. Each unit farm within the circle has an area of A_u ha. We assume these unit areas are distributed uniformly over the entire farmland within the circle.

We assume that the supply area j has a radius of R . We divide the circle into k sectors where in some sectors biomass is not grown (the area is used for other purposes). The area of the circle has to be increased by a ratio of $[n=k/(k-1)]$ to compensate for sectors that do not bear biomass. For example if we divide the circle area into 4 sectors and 1 sector does not contain biomass, the circle area has to increase by 4/3 in order to compensate for the unproductive sector. The effective radius R (km) of the circle is calculated from,

$$R = 10^{-5} \left(\frac{nA}{\pi} \right)^{1/2} \quad \text{B-1}$$

where n is the sector factor as defined above. A is the area (ha) of the circle. A is estimated from the total annual biomass demand Q , and average biomass yield Y_s (t/ha),

$$A_c = \frac{Q}{Y_s} \quad \text{B-2}$$

The cultivated area may be made of many smaller farmlands spread over a larger area. This area can be calculated as,

$$A_c = \frac{A_c}{Y_s} \quad \text{B-3}$$

where ϕ is a fraction of the area that is occupied by harvestable stover. Y_s is the estimated final yield of the biomass after the yield has been discounted for soil conservation and willingness of the farmer to participate in biomass collection. Y_s is also have to be adjusted for the capability of the harvest machine and potential losses from the time of cut to the time of delivery to biorefinery. These factors are summarized in the following equation

$$Y_s = \min [k_1 \ k_2] (1-k_3) Y \quad \text{B-4}$$

Where Y is the yield. k_1 represents a the maximum fraction of the biomass that can be removed without long term damage to soil fertility. Factor k_2 is the maximum fraction of the harvest biomass that the harvest machine is capable of removing. Height of cut and the quality of biomass affects k_2 . Equation B-

4 uses the smaller value of k_1 or k_2 . Factor k_3 represents the fraction of dry matter lost during harvest and subsequent handlings. For crop residue, the value of Y is usually estimated from the grain yield

$$Y = k Y_g$$

B-5

Where Y_a is grain yield in Mg/ha (dry mass). Factor k is the mass ratio of biomass to grain. Factor of k varies with different grain crop varieties, cultural practices, and growing conditions. For wheat k is estimated as 1.3 and for stover as 1.0.

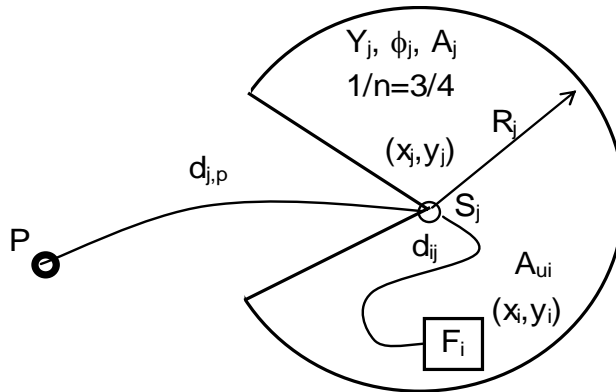

Figure B-1. Modeling of the biomass storage and transport from unit farms (F_i) to a storage site and to or processing plant P .

The biomass that is piled on the edge of each of the unit farms ought to be loaded on trucks and transported to S_j and/or processing plant. The net distance d_{ij} a truck has to travel is,

$$d_{ij} = \tau \left[(x_i - x_j)^2 + (y_i - y_j)^2 \right]^{1/2} \quad \text{B-5}$$

where x and y are coordinates of the unit farms F_i and storage S_j . τ is a winding factor to account for deviations from a straight line between the farm and the storage site.

APPENDIX C

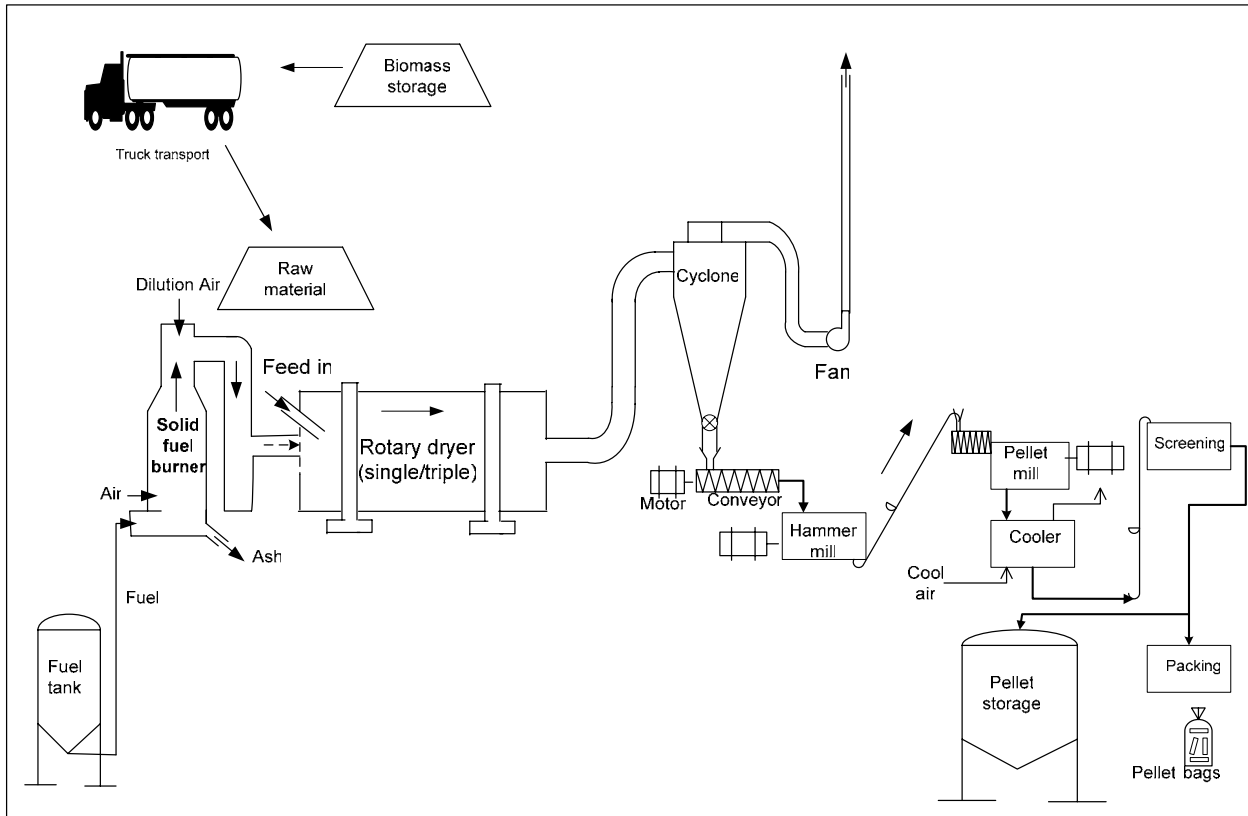

Figure C1. A schematic of pelletization plant used for cost analysis