

# *Economic, Environmental and Social Benefits of 2<sup>nd</sup>-Generation Biofuels in Canada*

Warren Mabee  
University of British Columbia

March 2006



A BIOCAP  
Research Integration Program  
Synthesis Paper



[www.biocap.ca](http://www.biocap.ca)



This paper was supported by BIOCAP through a targeted research program.

The report reflects the research findings and opinions of the research team and not necessarily those of BIOCAP Canada.

## IN Executive Summary

Canada's energy sector will likely change in significant ways over the course of the 21st century. Increasing volatility in the market for refined petroleum products, including transportation fuels, has spurred tremendous interest in creating a renewable and sustainable alternative that can fuel our cars and our economy. A new generation of transportation fuels based on lignocellulosic biomass are one viable option.

Previous disruptions to petrochemical supplies, such as the oil crisis of 1973, had led to the development of a first generation of biofuels, particularly sugar- and starch-based ethanol and vegetable oil-based biodiesel. These renewable transportation fuels were favoured because of their ease of use. These fuels may be distributed and sold from existing infrastructure, and when blended with conventional fuels, can be utilized within modern engines without modification. These 1<sup>st</sup>-generation biofuels have become commonplace in Brazil, parts of Europe, and in North America. One drawback with 1<sup>st</sup>-generation biofuels is that they are limited by feedstock availability, and compete with food applications. Thus their overall contribution to our demand for liquid transportation fuels is reduced.

Since 1998, oil prices have again been on the rise, due to a combination of growing demand for petroleum products, increasing instability in the Middle East, and natural disasters that have adversely affected productivity. One response has been a quick expansion of 1<sup>st</sup>-generation biofuel production in both Canada and the United States. At the same time, other bio-based options for transportation fuels have been resurrected and re-examined. Technological advancements and innovations have provided us with pathways towards a second generation of biofuels that have the potential to replace significant portions of North American transportation fuel demand.

This report presents two transformative technologies that could be used to expand the production of 2<sup>nd</sup>-generation biofuels in Canada, and deliver additional energy products that can maximize economic and environmental benefits to the industry. These technologies include advanced thermochemical systems that reduce wood to its most basic gaseous components through pyrolysis or gasification, and bioconversion systems that can isolate the building-block chemicals of wood.

The thermochemical platform typically uses a combination of pyrolysis, gasification, and catalysis to transform wood into syngas - the gaseous constituents of wood - and then into fuels or chemicals. Syngas production through pyrolysis is accompanied by the generation of char, which can then be gasified to provide process heat and energy for the thermochemical platform. A variety of commercial-scale processes exist to transform fossil fuels such as coal or natural gas into liquid fuels, including Fischer-Tropsch fuels. However, the use of biomass instead of fossil fuels changes the composition of syngas, creating a more heterogeneous intermediate product and increasing the difficulty in downstream catalysis. A range of technical problems must be overcome before biomass becomes a commercially-viable substitute for fossil feedstocks in 2<sup>nd</sup>-generation biofuel production. However, elements of the thermochemical platform are highly suitable for bioenergy production.

The bioconversion platform typically uses a combination of physical or chemical pretreatment and enzymatic hydrolysis to convert lignocellulose into its component monomers. Once liberated, the carbohydrate components of wood may be processed into a number of chemical and fuel products. A number of US-led projects are paving the way for new chemical products from the lignocellulose-based biorefinery, including bioethanol, lactic acid and polylactide, propanediol, and succinic acid. Cellulosic-based bioethanol from a demonstration-scale plant in Ottawa is already being produced and blended as an oxygenate in fuels. Other chemical products can be used to create consumer products such as bioplastics, or as platform chemicals in a number of industrial applications. The development of better ways to separate lignin from the lignocellulose matrix during bioconversion has created the possibility of developing value-added lignin-based products as well. The bioconversion platform therefore has the ability to serve as the basis for full-fledged wood-based biorefining operations, generating value-added bioproducts as well as fuel and energy for the forest sector.

Using components of these platforms, forest biomass can provide a sustainable, renewable source of bioenergy for Canada. This report illustrates how evolutions in technology may be combined to create truly revolutionary processes that can transform the energy sector. It is also shown how each technological platform might be used to generate other, valuable chemical products or energy, thus creating a biorefinery. A key recommendation is that the development of the biorefinery should take precedence over specific biofuel and bioenergy projects.

This report makes a number of key recommendations, summarized in the last section. In brief, they are as follows:

- Develop a comprehensive strategy for 2<sup>nd</sup>-generation biofuel development that includes minimizing risk for infrastructure development, as well as economic incentives for bioenergy production and consumption
- Funding for RD&D should be linked to development of biorefinery facilities;
- 2<sup>nd</sup>-generation biofuel funding should be harmonized with renewable energy programs and other synergistic programs, such as rural employment and agricultural assistance programs;
- Continue funding to address technical challenges and hurdles in the development of transformative technologies at all levels of research, development and deployment;
- Create specialized programs to support specific 2<sup>nd</sup>-generation biofuels; and
- Establish a Centre for Innovation that brings together Canadian capacity in biorefinery research, involving government, industry, and university players.

## Table of Contents

Executive Summary .....	2
1 Introduction .....	5
1.1 Petrochemical trends.....	7
2 Literature Review .....	8
2.1 Biofuel platforms.....	8
2.2 Bioconversion platform.....	9
2.2.1 Process overview .....	9
2.2.2 Current status .....	11
2.2.3 Challenges for commercialization.....	11
2.3 Thermochemical platform.....	12
2.3.1 Process overview .....	12
2.3.2 Current status .....	14
2.3.3 Challenges for commercialization.....	14
2.4 Greenhouse gas production.....	15
3 Data Review.....	17
3.1 Biofuel potentials .....	17
3.2 Lignocellulosic feedstocks in Canada .....	17
4 Scenarios: .....	20
4.1 IPCC Scenario interpretation .....	20
4.1.1 Background .....	20
4.1.2 Rationale.....	21
4.1.3 Approach .....	21
4.2 IPCC Scenario Application.....	23
5 Discussion.....	25
5.1 Model outcomes .....	25
5.2 Meeting Canada's GHG commitments.....	27
5.3 Economic and social implications .....	29
5.4 Coproduct generation with thermochemical platforms.....	31
5.5 Coproduct generation with bioconversion .....	32
6 Conclusions .....	34
7 Recommendations .....	36
8 References.....	38

# 1 Introduction

In the fall of 1973, the OPEC nations of the Middle East stopped exports to the US and other western nations in retaliation for western support of Israel. This forced oil prices up by over 400% in the United States within a few months, radically impacting the economy. A number of responses, including introduction of nation-wide speed limits, fuel economy guidelines and targets, and tax credits for alternative energy were introduced. These responses have to a large degree guided American energy policy to this date. Canada, as the largest trading partner of the US, has also felt the impacts of these responses, and has developed a complementary suite of policies.

One of the outcomes of the 70's oil crisis was the development of a first generation of biofuels, particularly sugar- and starch-based ethanol and vegetable oil-based biodiesel. These renewable transportation fuels were favoured because of their ease of use. These fuels may be distributed and sold from existing infrastructure, and when blended with conventional fuels, can be utilized within modern engines without modification. These 1<sup>st</sup>-generation biofuels have become commonplace in Brazil, parts of Europe, and in North America.

One drawback with 1<sup>st</sup>-generation biofuels is that they are limited by feedstock availability. Bioethanol may be made from sugar, extracted from sugarcane or sugar beet, and from starch, a major component of cereal crops. Use of these feedstocks for fuel thus competes with higher-value livestock or human foods in many cases, which limit the extent to which they may be dedicated to fuel supply. Oilseed, the primary natural source of biodiesel, is derived from crops with limited spatial ranges and which have many high-value food-related applications. In many regions of the world, the physical constraint of available agricultural land means that 1<sup>st</sup>-generation biofuels cannot replace traditional fossil-based fuels to a significant degree.

Production of 1<sup>st</sup>-generation biofuels began to rise in the 1980's. Relatively low prices for oil throughout the 1980's and early 1990's meant that the impetus for expanding production of these fuels in North America came from the farmers and associated lobby groups. In the United States, starch-based ethanol from corn was supported by the National Corn Growers Association as a means of diversifying the rural economy. Similar drivers were seen in Austria, where biodiesel production developed over these decades. During this period, research and development continued to address issues around non food-based feedstocks for biofuels.

Since 1998, oil prices have again been on the rise, due to a combination of growing demand for petroleum products, increasing instability in the Middle East, and natural disasters that have adversely affected productivity. One response has been a quick expansion of 1<sup>st</sup>-generation biofuel production in both Canada and the United States. At the same time, other bio-based options for transportation fuels have been resurrected and re-examined. Thirty years of technological advancement and innovation have provided us with a second generation of opportunities that have the potential to replace significant portions of North American transportation fuel demand.

The second generation of biofuels differs from the first in that the proposed feedstock for production is much more heterogeneous. Where 1<sup>st</sup>-generation biofuels used agricultural products, including starch and vegetable oil, 2<sup>nd</sup>-generation biofuels will use lignocellulose, a complex matrix that incorporates cellulose, hemicellulose, and lignin and which forms the structural components of plants and trees (Atchison 1993, Sjöström 1993). A simplified flowchart detailing biomass-to-fuel pathways for both 1<sup>st</sup>- and 2<sup>nd</sup>-generation biofuels is shown in Fig. 1-1.

Fig. 1-1: Biomass-to-Fuel Pathways (Simplified)

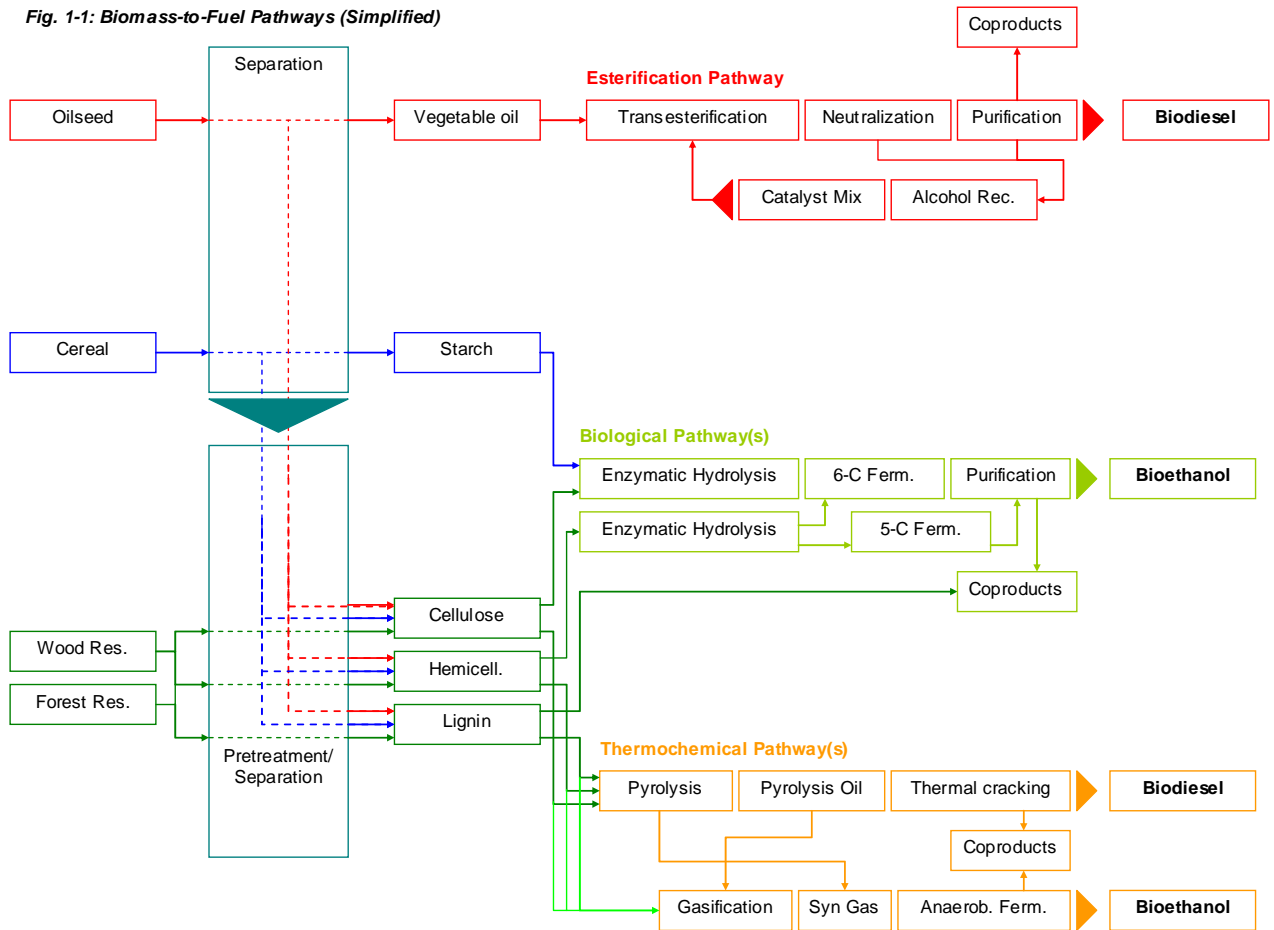

A key observation from the figure is that every biofuel pathway links fuel production to the generation of coproducts. In 1<sup>st</sup>-generation biofuel production, coproducts play an essential role in process economics, adding value and profit to production. The pathways for biofuel production become more complex as one moves from starch to wood residues. As complexity is added, however, opportunities arise for coproduct generation, and these opportunities may more than compensate for additional processing costs.

In this report, we examine 2<sup>nd</sup>-generation biofuels, considering both the current state of the technology and near-future technology developments. The report focuses on lignocellulosic-based ethanol, derived through biological pathways, and 'biosyn' diesel, derived through thermochemical pathways. We assess the ability of these technologies to provide fuels under a variety of climate-change scenarios, theoretically reducing volatility in the Canadian energy sector. We use these scenarios to measure the ability of 2<sup>nd</sup>-generation fuels to reduce national greenhouse gas emissions and improve environmental performance, increase resource sector employment, and encourage regional development. A number of recommendations are provided to policymakers.

### 1.1 Petrochemical trends

Since 1998, oil prices have again been on the rise, due to a combination of growing demand for petroleum products. This upward trend has become more pronounced over the past two years, as markets have coped with war in the Middle East, rising demand in China and India, a declining rate of new oil discoveries, and increasing costs for production. After Hurricane Katrina, oil prices reached new highs of more than \$70/barrel; for a brief period, gasoline rationing was discussed, and line-ups at gas stations reminiscent of the previous oil crisis of the 1970's were observed. Fig. 1-2 details crude oil prices for West Texas Intermediate Crude since 1997. The continuing high price of oil (>\$60/barrel) has created a situation that has potential to derail the North American economy and lead to recession in both the US and Canada.

Swings of over \$10 per barrel are now quite common, creating uncertainty in the fuel market. The global nature of the petroleum industry means that these swings have impacted consumers in Canada, even though this country is a net exporter of petroleum, and has benefited from higher prices in terms of balance of trade and GDP. The impact that unstable fuel prices may have on the overall economy has encouraged governments in Canada and the US to look seriously at alternative fuels, which might help stabilize prices (albeit at a higher cost per litre). In the latest State of the Union speech, President Bush publicly vowed to make ethanol from forest and agricultural biomass viable within six years.

The increase in the value of a barrel of oil, or a litre of refined fuel, creates a situation where technologies once considered uneconomical can become mainstream, and where untraditional players - such as the Canadian forest industry - may suddenly become important participants. Strong government support in the US and Canada can bring these technologies to commercial success.

Fig 1-2: Crude oil prices, US\$/barrel, 1996-2006

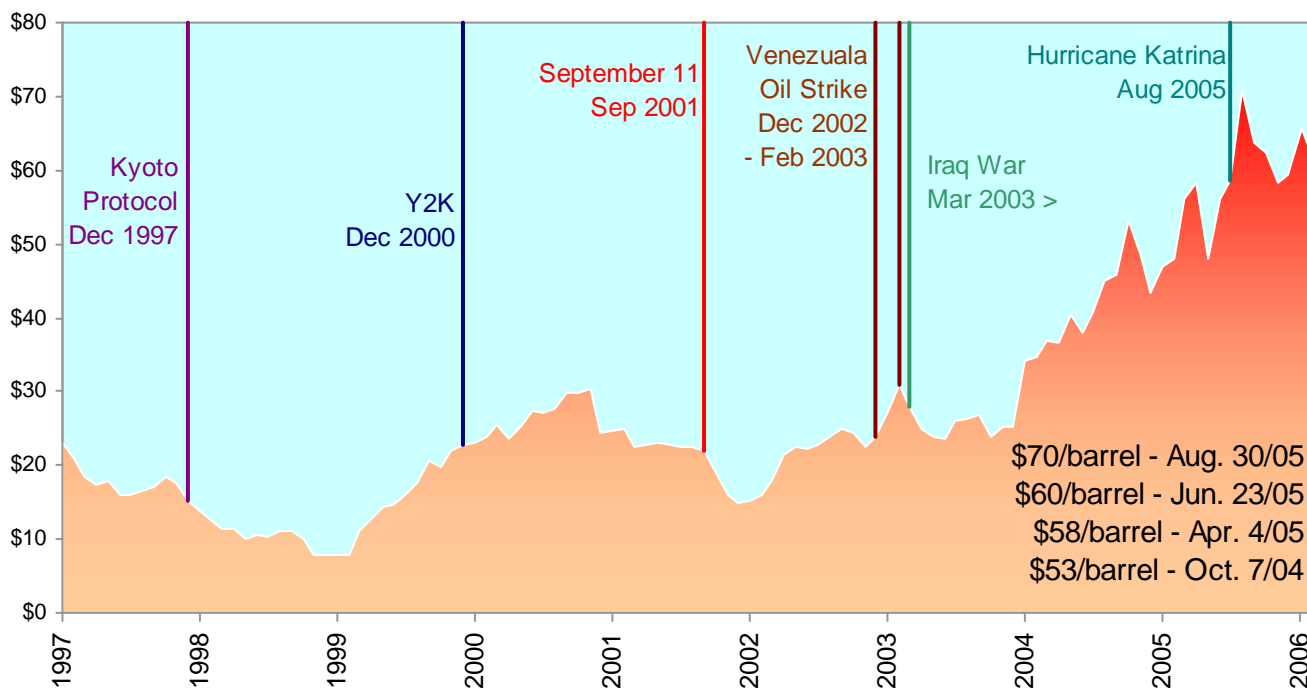

Source: Economag (2006).

## 2 Literature Review

### 2.1 Biofuel platforms

The technical platform chosen for 2<sup>nd</sup>-generation biofuel production will be determined in part by the characteristics of the biomass available for processing. The majority of terrestrial biomass available is typically derived from agricultural plants and from wood grown in forests, as well as from waste residues generated in the processing or use of these resources. Today, the primary barrier to utilizing this biomass is generally recognized to be the lack of low-cost processing options capable of converting these polymers into recoverable base chemical components (Lynd et al. 1999).

In the United States, much of the biomass being used for 1<sup>st</sup>-generation biofuel production includes agricultural crops that are rich in sugars and starch. Because of the prevalence of these feedstocks, the majority of US activity towards developing new products has focused on the bioconversion platform (BRDTAC 2002a). Bioconversion isolates sugars from biomass, which can then be processed into value-added products. Native sugars found in sugarcane and sugar beet can be easily derived from these plants, and refined in facilities that require the lowest level of capital input. Starch, a storage molecule which is a dominant component of cereal crops such as corn and wheat, is comprised wholly of glucose. Starch may be subjected to an additional processing in the form of an acid- or enzyme-catalyzed hydrolysis step to liberate glucose using a single family of enzymes, the amylases, which makes bioconversion relatively simple. Downstream processing of sugars includes traditional fermentation, which uses yeast to produce ethanol; other types of fermentation, including bacterial fermentation under aerobic and anaerobic conditions, can produce a variety of other products from the sugar stream.

Forest biomass or agricultural residues are almost completely comprised of lignocellulosic molecules (wood), a structural matrix that gives the tree or plant strength and form. This type of biomass is a prime feedstock for combustion, and indeed remains a major source of energy for the world today (FAO 2005). The thermochemical platform utilizes pyrolysis and gasification processes to recover heat energy as well as the gaseous components of wood, known as synthesis gas or 'syngas'. Syngas can then be refined into synthetic fuels, including Fischer-Tropschs, methanol, and ethanol, through the process of catalytic conversion.

Lignocellulose is a complex matrix combining cellulose, hemicellulose, and lignin, along with a variable level of extractives. Cellulose is comprised of glucose, a six-carbon sugar, while hemicellulose contains both five- and six-carbon sugars, including glucose, galactose, mannose, arabinose, and xylose. The presence of cellulose and hemicellulose therefore makes lignocellulose a potential candidate for bioconversion. The ability of the bioconversion platform to isolate these components was initially limited, as the wood matrix is naturally resistant to decomposition. Recent advances, however, have made this process more commercially viable. Costs remain higher than for starch-based bioconversion, but there is added potential for value-added products that can utilize the lignin component of the wood.

In order to incorporate all aspects of biofuel production, including the value of coproducts and the potential of the industry to diversify their product offering, we employ the biorefinery concept. The biorefinery concept is important because it offers many potential environmental, economic, and security-related benefits to our society. Biorefineries provide the option of co-producing high-value, low-volume products for niche markets together with lower-value commodity products, such as industrial platform chemicals, fuels, or energy, which offsets the higher costs that are associated with processing lignocellulosics (Keller 1996, BRDTAC 2002b).

The two technological platforms being explored for the lignocellulose-based biorefinery are complementary. Each technological platform provides different intermediate products for further processing. It is the range of these intermediates that dictates the types of end products that are likely to be successful in a commercial sense.

## 2.2 Bioconversion platform

### 2.2.1 Process overview

The bioconversion platform uses biological agents to carry out a structured deconstruction of lignocellulose components. This platform combines process elements of pretreatment with enzymatic hydrolysis to release carbohydrates and lignin from the wood. An overview of the bioconversion platform is provided in Fig. 2-1.

Fig. 2-1: Bioconversion platform flowchart (Mabee et al. 2005)

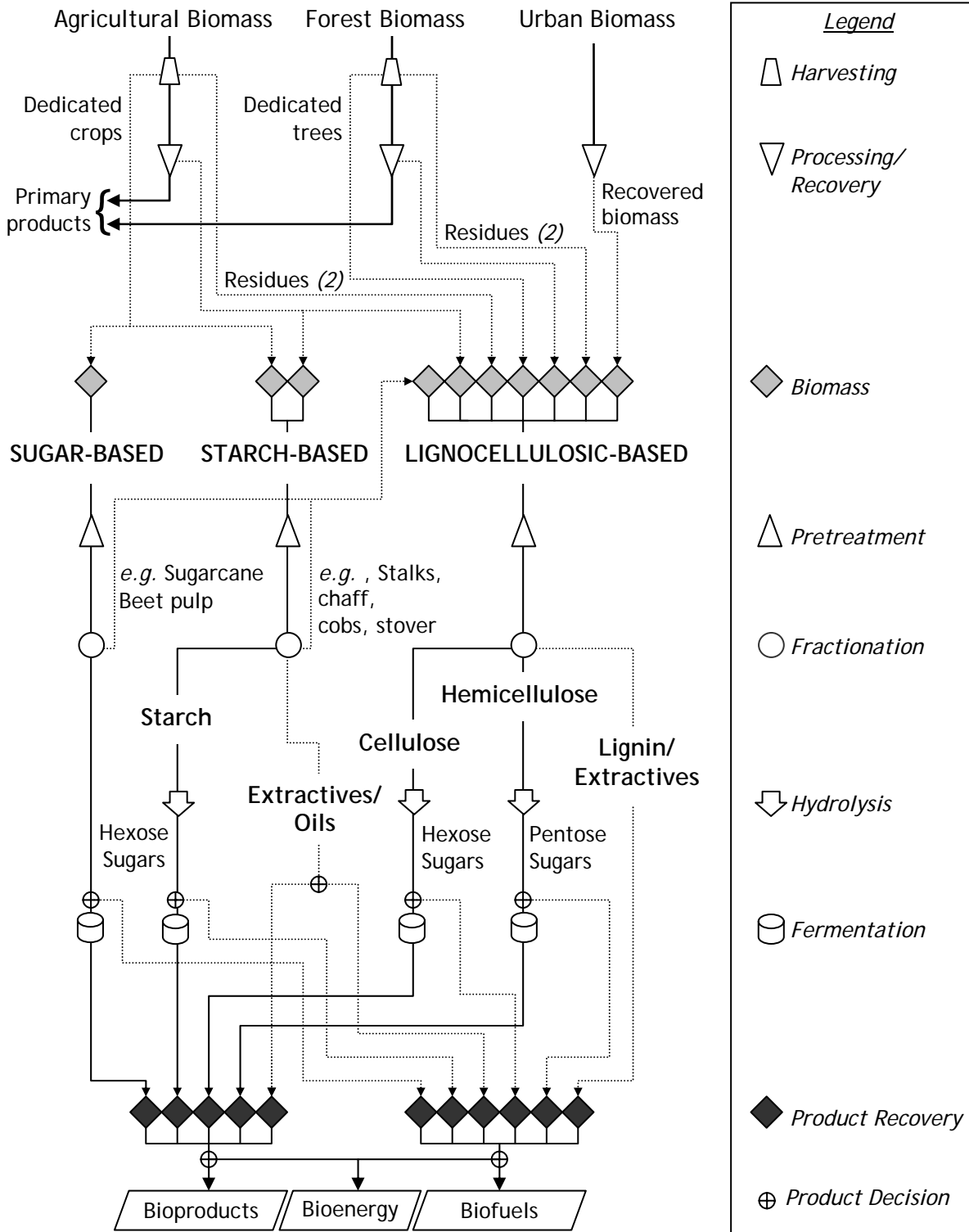

The first step, as shown in the figure, is a pretreatment stage which must optimize the biomass feedstock for further processing. In the bioconversion platform, this step must be designed to expose cellulose and hemicellulose for subsequent enzymatic hydrolysis, increasing the surface area of the substrate for enzymatic action to take place. Like in traditional pulping, lignin is either softened or removed, and individual cellulosic fibres are released creating pulp. While bioconversion pretreatment is based on existing pulping processes, however, traditional pulping parameters are defined by resulting paper properties and desired yields, while optimum bioconversion pretreatment is defined by the accessibility of the resulting pulp to enzymatic hydrolysis.

In order to improve the ability of the pretreatment stage to optimize biomass for enzymatic hydrolysis, a number of non-traditional pulping techniques are being examined by a consortium of Canadian and US researchers, including our group at UBC. The Biomass Refining Consortium for Applied Fundamentals and Innovation (CAFI) has set its objective as advancing the efficacy and knowledge base of pretreatment technologies (Wyman et al. 2005). The pretreatments being considered by the consortia include water-based systems, such as steam-explosion pulping; acidic treatments, using concentrated or dilute acids such as H<sub>2</sub>SO<sub>4</sub>; alkaline treatments that utilize recirculated ammonia or modified steam-explosion (AFEX); and organic solvent pulping systems, such as acetic acid or ethanol. As with traditional pulping, these pretreatments tend to work best with a homogenous batch of wood chips. Some have observed that different pretreatments seem to be better suited to different types of lignocellulosic feedstocks (e.g. Mabee et al. 2006a).

Once pretreated, the cellulose and hemicellulose components of wood can be hydrolyzed. Almost all commercial hydrolysis programs today use enzymes to facilitate fast, efficient, and economic bioconversion of the wood. Enzymatic hydrolysis of lignocellulosics uses cellulases most commonly produced by fungi such as *Trichoderma*, *Penicillium*, and *Aspergillus* (Galbe et al. 2002). A cocktail of cellulases is required in order to break down the cellulosic microfibril structure into its carbohydrate components in an efficient manner, unlike the bioconversion of starch, which has a simpler chemical structure. The enzymatic hydrolysis step may be completely separate from the other stages of the bioconversion process, or it may be combined with the fermentation of carbohydrate intermediates to end-products. Separate hydrolysis and fermentation (SHF) offers the platform more flexibility, and makes it easier in theory to alter the process for different end products; however a separate process requires additional engineering and will cost more to build and operate. Simultaneous saccharification and fermentation (SSF) has been found to be highly effective in the production of specific end products, such as bioethanol (Gregg et al. 1998, Galbe et al. 2002, Mabee et al. 2006a)

Separation techniques are being developed to isolate the base components of cellulose, hemicellulose and lignin in order to facilitate industrial processing of these components. Sometimes, the most effective isolation may be carried out by combining correct pretreatments with enzymatic hydrolysis (Mabee et al. 2006a). The strength of the bioconversion platform is that it provides a range of intermediate products, including glucose, galactose, mannose, xylose, and arabinose, which can be relatively easily processed into value-added bioproducts. The bioconversion platform also generates a quantity of lignin or lignin components; depending upon the pretreatment, lignin components may be found in the hydrolysate after enzymatic hydrolysis, or in the wash from the pretreatment stage. The chemical characteristics of the lignin are therefore heavily influenced by the type of pretreatment that is employed. Finally, a relatively small amount of extractives may be retrieved from the process. These extractives are highly variable depending upon the feedstock employed, but may include resins, terpenes, or fatty acids.

Once hydrolyzed, six-carbon sugars can be fermented to ethanol using age-old yeasts and processes. Five-carbon sugars, however, are more difficult to ferment; new yeast strains are being developed that can process these sugars, but issues remain with process efficiency and the length of fermentation. Based on a review of the literature, it is estimated that ethanol yields from lignocellulosics will range between 0.12 and 0.32 L/kg undried feedstock, depending upon the efficiency of five-carbon sugar conversion. (Gregg et al. 1998, Lawford et al. 1999, 2001, Wingren et al. 2003). Other types of

fermentation, including bacterial fermentation under aerobic and anaerobic conditions, can produce a variety of other products from the sugar stream, including lactic acid.

### 2.2.2 *Current status*

A large number of technical reports on aspects of bioconversion are available; for examples see Sassner et al. (2005), Berlin et al (2005), and Mabee et al. (2004). The environmental performance of bioethanol, including air quality (NO<sub>x</sub>, PM, SO<sub>x</sub>, etc.) is also well documented; examples include Kempainen and Shonnard (2005), MacLean and Lave (2003) and Sheehan and Himmel (2001). A number of reports provide mass- and energy- balances of the bioconversion process; for examples see Schulz and Hebecker (2005) and Gravitis et al. (2004). Economic analyses are also plentiful, such as those provided by Wingren et al. (2003) and Rosenberger et al. (2002).

Bioconversion platforms for lignocellulosics-to-ethanol are beginning to become commercially viable. One of the major proponents of bioconversion-to-ethanol is the Iogen Corporation, based in Ottawa. This company has worked since the 1970's to commercialize their proprietary approach, and their demonstration plant has been producing lignocellulose-based ethanol since April 2004 (Iogen 2004). Other major commercial development in this area is being spearheaded by Abengoa Bioenergy, who are constructing a demonstration bioconversion facility at their mill in Salamanca, Spain. This project has Canadian participation from SunOpta Inc., who are providing project engineering and proprietary technology to the project (DOE 2006a).

A number of pilot or process demonstration scale units are also available to support the commercialization process. These include university-based process demonstration facilities in the United States, Canada, Sweden, and Denmark. Pilot-scale facilities include the Etek Etanolteknik pilot facility in Sweden and the National Renewable Energy Laboratory pilot facility in the USA. Abengoa Bioenergy is constructing a pilot facility to explore corn stover-to-ethanol technology at their facility in York, Nebraska (DOE 2006a).

### 2.2.3 *Challenges for commercialization*

The most fundamental issues for the bioconversion platform include improving the effectiveness of the pretreatment stage, decreasing the cost of the enzymatic hydrolysis stage, and improving overall process efficiencies by capitalizing on synergies between various process stages. There is also a need to improve process economics by creating coproducts that can add revenue to the process.

Pretreatment research is occurring in a number of laboratories around the world, including Europe, Japan, and North America. As previously mentioned, a number of non-traditional pulping techniques are being examined by a consortium of Canadian and US researchers. The Biomass Refining Consortium for Applied Fundamentals and Innovation (CAFI) is dedicated to advancing pretreatment technologies, as related to specific feedstocks. In its first round of funding, CAFI members worked with corn stover, while the second round of funding has focused on poplar. The third round of funding, yet to be formally announced, may focus on switchgrass or a perennial lignocellulosic feedstock.

Other fundamental research into the dynamics of bioconversion has lately been focused on the cost of enzymatic hydrolysis, which must be tailored to the complexity of the lignocellulosic matrix. Coordinated projects between Novozymes, Genencor, and the National Renewable Energy Laboratory in the United States succeeded in reducing the cost of enzymatic hydrolysis on ideal substrates by about 30-fold over four years (Novozymes 2005).

Integration of various process steps and increasing overall process efficiency is being improved by integrated research programs, which combine process development units with pilot or demonstration-scale facilities around the world. Process development units are operating at the University of British Columbia, at Lund University in Sweden, and in the United States at the National Renewable Energy Lab (NREL). Networks of researchers that work at different process scales have combined their efforts to address this issue. It should be pointed out that most of these facilities have been designed to produce bioethanol as their primary product, but can be configured to examine a variety of coproducts.

## 2.3 Thermochemical platform

### 2.3.1 Process overview

This platform uses thermochemical processes to gasify wood, producing synthesis gases (sometimes called producer gases). This platform combines process elements of pretreatment, pyrolysis, gasification, cleanup and conditioning to generate a mixture of hydrogen, carbon monoxide, carbon dioxide, and other gases. The products of this platform may be viewed as intermediate products, which can then be assembled into chemical building blocks and eventually end products (OBP 2003). An overview of the bioconversion platform is provided in Fig. 2-3.

Fig. 2-3: Bioconversion platform flowchart (Mabee et al. 2006)

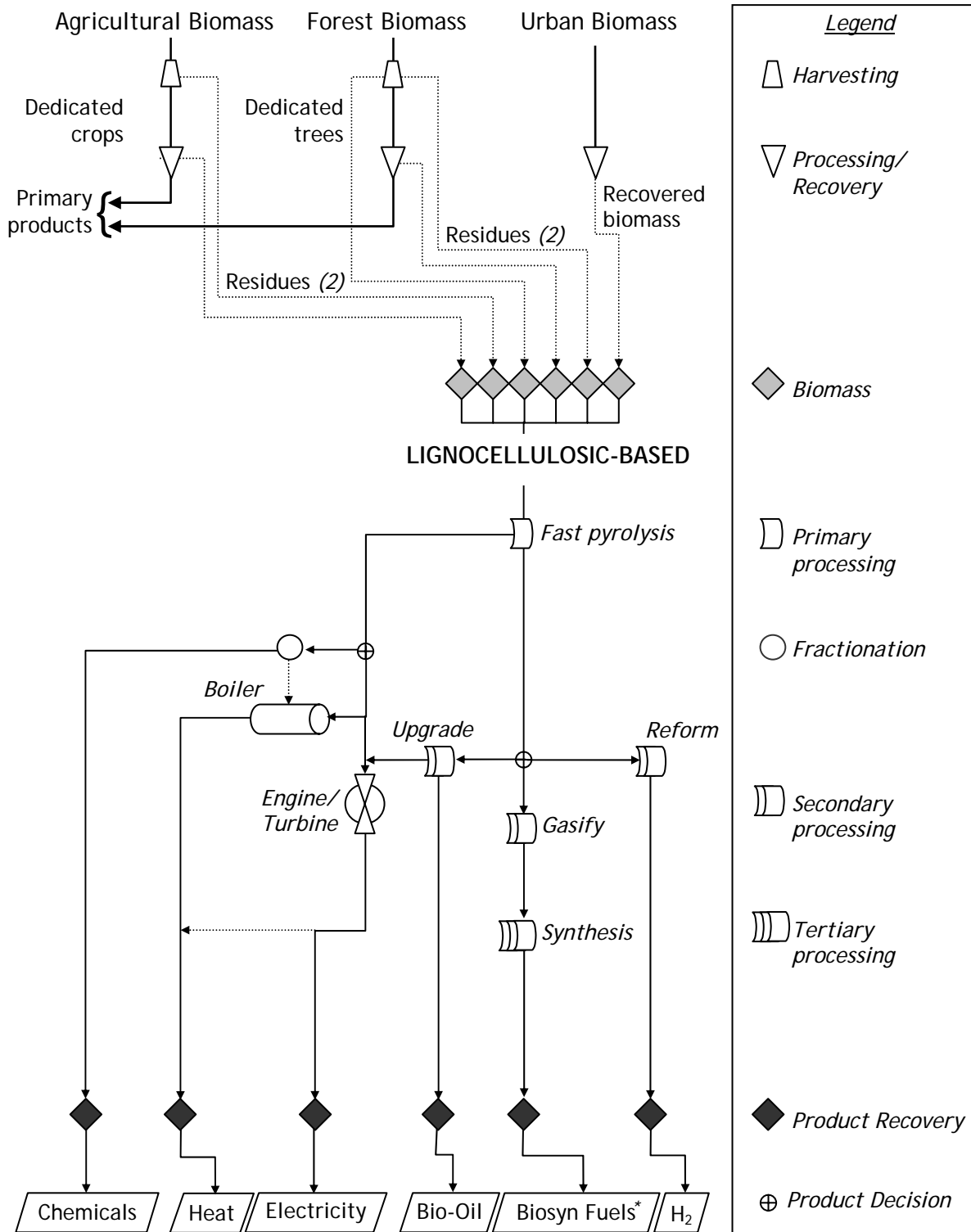

In the thermochemical platform, the only pretreatment required involves drying, grinding, and screening the material in order to create a substrate that can easily be fed into the reaction chamber. The technology required for this stage is already available on a commercial basis, and is often associated with primary or secondary wood processing, or agricultural residue collection and distribution.

In the primary processing stage, the volatile components of biomass are subjected to pyrolysis, or combustion in the absence of oxygen, at temperatures ranging from 450° - 600° C. Depending on how fast the pyrolysis stage is carried out, a variety of products can be achieved. If pyrolysis is carried out quickly (fast pyrolysis), a combination of vapours, condensable vapours, and char is produced. The condensation of these products creates a bio-oil, which can under ideal conditions make up 60-75% of the original fuel mass. The oil produced can be used as feedstock for value-added chemical products, or possibly as a biofuel (Garcia et al. 2000). If the pyrolysis is carried out at a slower rate (slow pyrolysis), the vapours that are formed are less likely to condense into bio-oil. The vapours themselves consist of carbon monoxide, hydrogen, methane, carbon dioxide and water, as well as volatile tars.

Slow pyrolysis, like fast pyrolysis, leaves behind a solid residue of char (or charcoal), which comprises about 10-25% of the original fuel mass. Processing this material requires a second gasification stage. Char conversion occurs at temperatures of 700°-1200° C, at which temperatures the char reacts with oxygen in order to produce carbon monoxide (CANMET 2005, Cetin et al. 2005). If the pyrolysis is carried out at the higher temperature range (550° - 600° C), a vapour is formed which consists of carbon monoxide, hydrogen, methane, volatile tars, carbon dioxide and water. High temperature pyrolysis leaves behind a solid residue of char (or charcoal), which makes up about 10-25% of the original fuel mass. This material can then be gasified at temperatures of 700°-1200° C, and used as a fuel source to drive the pyrolysis process (Cetin et al. 2005). All gaseous products from pyrolysis and gasification are generally referred to as synthesis gases (or syngas).

After the production of syngas, a number of pathways may be followed to create 2<sup>nd</sup>-generation biofuels or other chemical, heat, or energy products, as shown in Fig. 2-3. It is possible to create one potential biofuel from the thermochemical platform without a catalysis stage. Bio-oil has been advocated as a substitute for bunker-grade heating oil, and is approved for use in district heating utility boilers in Sweden. It has been mixed with coal in a co-firing facility in the United States successfully. The CANMET Energy Technology Centre is exploring a micro emulsion process that allows bio-oil to be mixed with conventional diesel engines. Other biofuels may be generated by applying a catalysis stage. The truly 'revolutionary' aspect of the thermochemical platform is its ability to use this approach to convert syngas into chemical building blocks and eventually end products. Proven catalytic processes for syngas conversion to fuels and chemicals exist using syngas produced commercially from natural gas and coal. These proven conversion technologies can be applied to biomass-derived syngas.

Methanol is one potential biofuel that can be generated through catalysis. The majority of methanol produced today is being derived from natural gas, however. Methanol has a high octane number (129) but relatively low energy (about 14.6 MJ/l) compared to gasoline (91-98 octane, 35 MJ/l). Methanol is mostly used to create MTBE, which is used as an octane booster today. Conceivably, methane could be used in higher or as a stand alone fuel, although this would require significant infrastructure changes as well as modifications to conventional engines. Because methanol has a favourable hydrogen:carbon ratio (4:1), it is often touted as a potential hydrogen source for future transportation systems.

Another potential biofuel that can be produced through the thermochemical platform is Fischer-Tropsch diesel (or biosyn diesel). This fuel was first discovered in 1923 and is commercially based on syngas made from coal, although the process could be applied to biomass-derived syngas. The process of converting CO and H<sub>2</sub> mixtures to liquid hydrocarbons over a transition metal catalyst has become known as the Fischer-Tropsch (FT) synthesis. Most existing production of FT-diesel was carried out in South Africa, in part because that country was under UN trade sanctions for many years and had no available source of petroleum for fuel production. Eventually, five plants were built in South Africa in

the 1980's and 1990's (three based on coal, and one based on natural gas); and a number of other natural gas-based plants have been commissioned or constructed around the world in the late 1990's.

Another potential catalytic conversion of biomass-based syngas is to higher alcohols, including ethanol. Ethanol and other higher alcohols form as by-products of both Fischer-Tropsch and methanol synthesis, and modified catalysts have been shown to provide better yields. The thermochemical platform provides the opportunity for a number of additional coproducts, as well as energy in the form of heat or electricity and biofuels. Each syngas component (i.e. CO, CO<sub>2</sub>, CH<sub>4</sub>, H<sub>2</sub>) may be recovered, separated, and utilized.

### 2.3.2 *Current status*

Pyrolysis/gasification systems have been reported to be much more efficient for energy recovery, in terms of electricity generation, than traditional combustion. It has been estimated that typical biomass steam generation plants have efficiencies in the low 20% range, compared to gasification systems with efficiencies that reach 60% (DOE 2006b). High efficiencies have been noted for both co-firing systems (where biomass is gasified together with a fossil fuel such as coal or natural gas) and in dedicated biomass gasification processes (Gielen et al. 2001). Because the potential for energy recovery is so much higher, gasification systems without any downstream catalysis may be able to increase bioenergy production with minimal impact on existing product streams in sawmilling or pulping operations. This type of 'evolutionary' technology application is a logical step on the path towards greater process efficiencies and increased energy self-generation. These types of systems could also provide surplus bioenergy, becoming an additional revenue stream and diversifying the economic portfolio of the Canadian forest industry.

In terms of 2<sup>nd</sup>-generation biofuel production, the majority of the literature focuses on a platform that links gasification technology to the Fischer-Tropsch synthesis process. From an environmental perspective, a number of studies are available that examine emissions associated with this fuel's use; for examples see Szybist et al. (2005) and Kahandawala et al. (2004). The economic and energy costs associated with these fuels use are addressed by a number of authors; for examples refer to Prins et al. (2005), who supply an exergy analysis of a combined gasification-Fischer-Tropsch synthesis system, and Hamelinck et al. (2004), who provide a mass/energy balance for biomass-based FT diesel systems, as well as an overview of costs and returns. Refining, blending and commercialization issues have also been addressed in the literature; see Tijmensen et al. (2002) for an example. Significant technical hurdles remain in the creation of 2<sup>nd</sup>-generation biofuels through the thermochemical platform, including syngas clean-up, char accumulation, and catalysis inhibition.

While thermochemical-derived 2<sup>nd</sup>-generation biofuels are not yet technically proven, there are a number of pilot- and demonstration-scale pyrolysis or gasification facilities capable of processing biomass. These include government-run facilities in the CANMET Energy Technology Centre in Ottawa, as well as the Thermochemical Users Facility at the National Renewable Energy Lab in the United States. Canada is also home to a number of commercial ventures, including Ensyn, Enerkem, Dynamotive, and Nexterra. At the present time, most of these facilities are focused on creation of bioenergy (including Nexterra and Dynamotive), generating bio-oil (Dynamotive), or creating value-added components from the volatile tar components (Ensyn and Enerkem). In the United States, a number of commercial initiatives include projects led by Georgia Pacific, Boise Cascade, and Mississippi Ethanol LLC (DOE 2006c,d,e,f). At the present time, there are no commercial-scale biomass-based facilities for the production of fuels or chemicals using the thermochemical platform (Faaij 2006).

### 2.3.3 *Challenges for commercialization*

Gasification technologies for the production of fuels from biomass has been tested in Europe, but has failed to attract interest in the past due to the comparatively low price of fossil fuels (Faaij 2006). This is changing with rising fuel costs and uncertainty about the security of fossil reserves. Part of the problem with commercializing thermochemical fuels may be related back to the quality of bio-based synthesis gases, which are more heterogeneous than natural gas-based syngas. While technical approaches are

well documented for the production of hydrogen, methanol and FT liquids from syngas, the input gases must be relatively clean in order for these processes to function in a commercially viable sense. Therefore, before catalysis, raw syngas must be cleaned up in order to remove inhibitory substances that would inactivate the catalyst. These include sulphur, nitrogen, and chlorine compounds, as well as any remaining volatile tars. The clean-up of heterogeneous biomass-derived syngas is one of the primary technical issues that remains to be addressed.

The ratio of hydrogen to carbon monoxide may need to be adjusted and the carbon dioxide by-product may also need to be removed. One major problem with methanol synthesis is that biomass-based syngas tends to be hydrogen-poor compared to natural gas syngas. Methanol synthesis requires a ratio of 2:1 hydrogen:carbon monoxide to be cost-effective. Research is ongoing to allow lower ratio hydrogen:carbon monoxide syngas to be used. Again, this is a key issue in generating a value-added chemical component that could support biorefining operations.

Common problems associated particularly with Fisher-Tropsch synthesis are low product selectivity (the unavoidable production of perhaps unwanted coproducts, including olefins, paraffins, and oxygenated products), and the sensitivity of the catalyst to contamination in the syngas that inhibit the catalytic reaction. With biomass-based syngas, this problem is amplified due to the heterogeneous nature of the syngas. Research to improve the ability of catalysts to resist inhibitors is required to lower the cost of production to economic ranges.

A final issue, perhaps of greater concern to policymakers, is that deployment on a large scale is required to gain necessary economies of scale for most of these processes, where the cost of syngas production can easily be more than 50% of the total process cost (Spath and Dayton 2003). This means larger plants and ultimately fewer employees on a per-litre basis of fuel output. This requirement for large facilities raises the level of capital required for infrastructure development, increasing risk to the investor; it also increases the amount of biomass required for operation, which makes it more difficult to supply the facility over the course of its operational lifetime.

#### **2.4 Greenhouse gas production**

Greenhouse gas production associated with lignocellulosic-based feedstocks is anticipated to be much lower than with conventional fuels. The environmental performance depends very much on the specific life cycle of the fuel, including the country in which the life cycle assessment (LCA) was conducted, the feedstock on which the fuel is based, the vehicle used, the propulsion system, and the overall state of technology. Two major integrative reports have been carried out that have brought together the major LCA's conducted in a number of OECD countries in Europe and North America. One, the VIEWLS project, released their first report in November of 2005 (VIEWLS 2005). An earlier report by the Institute for Energy and Environmental Research in Heidelberg corroborates many of the findings in the VIEWLS report and provides some additional LCA reviews (Quirin et al. 2004).

In general, both reports show that fuels (and chemicals) made from lignocellulosic materials are characterized by reduced carbon dioxide emissions when compared to similar products derived from petroleum and thus can play a role in meeting Kyoto Protocol obligations or reduced pollution guidelines. Conventional fuels have emissions ranging between 160 to 190 g CO<sub>2</sub>-equivalent per kilometre; most biofuels, including the 2<sup>nd</sup>-generation fuels we are discussing in this report, can reduce these significantly. It is pointed out that substituting emissions by utilizing bio-based energy in all aspects of 2<sup>nd</sup>-generation biofuel production can create an overall negative emission for the fuel (VIEWLS 2005, Braune 1998). For the purpose of this report, we do not consider this potential, but rather simply focus on the potential of 2<sup>nd</sup>-generation biofuels to reduce GHG emissions in use.

The figure below illustrates the dramatically lower GHG emissions that are associated with 2<sup>nd</sup>-generation biofuel use. It is found that Fischer-Tropsch (F-T) fuels based on residues are likely to have the lowest possible emissions; this is typical of diesel propulsion systems that have better energy recovery. If energy crops are utilized as a feedstock, the overall emissions rise slightly, because the benefit of residue disposal is lost. Ethanol from residues or from energy crops also have relatively low emissions, particularly compared to conventional fuels including gasoline and diesel fuel.

For 2<sup>nd</sup>-generation ethanol from lignocellulosics, there is a potential to reduce GHG emissions with improved technology, which may be available post-2010. This reflects the close-to-commercial status of the technology today, and the anticipated improvements that will be seen as this technology improves. For F-T fuels, it is anticipated that commercial status will not be achieved until post-2010, reflecting the significant technical hurdles which must be met with this technology platform. There is also a potential to reduce emissions associated with gasoline and diesel production and use, which is reflected in the '>2010' figures below.

**Fig. 2-4: GHG emissions associated with 2<sup>nd</sup>-generation biofuels (g CO<sub>2</sub>-e/km)**

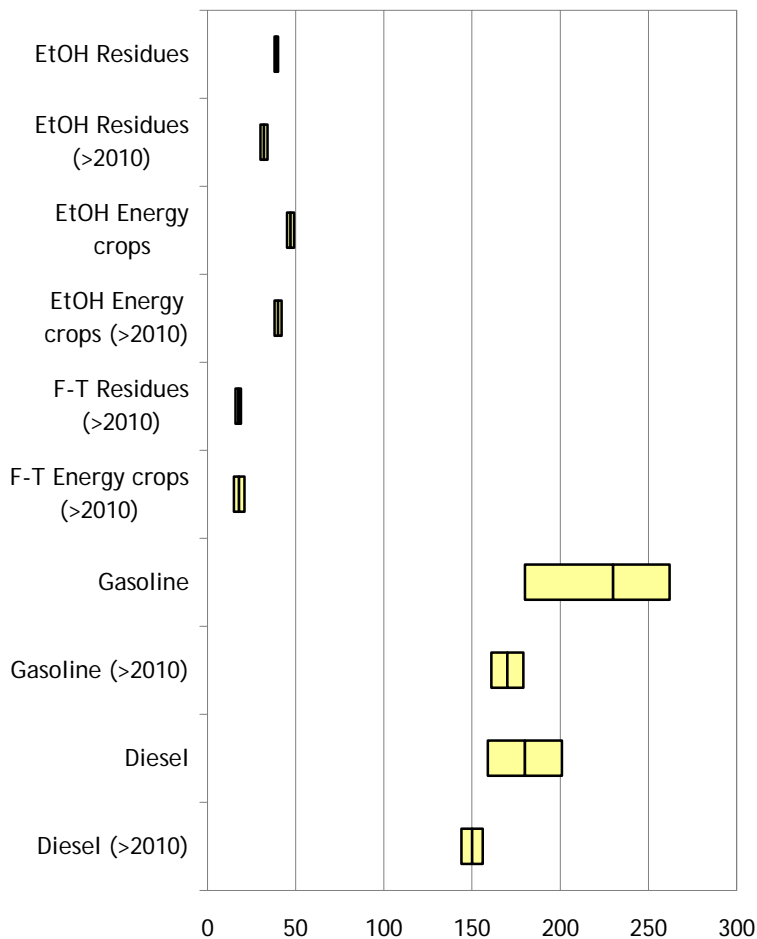

## 3 Data Review

### 3.1 Biofuel potentials

A forthcoming paper by Mabee et al. (2006b) has estimated the potential levels of Canadian bioethanol production from lignocellulosic sources. Based on a review of the literature, it was estimated that ethanol yields from lignocellulosics will range between 0.12 and 0.32 L/kg undried feedstock (Gregg et al. 1998, Wingren et al. 2003, Lawford et al. 1999, 2001). The lowest number represents yields that are currently achievable, while the higher numbers represent potential yields if certain technological issues, including the conversion of pentose sugars, can be achieved. In this report, we consider both the current (low) yield as well as the best yield in order to provide a range of potential 2<sup>nd</sup>-generation biofuel production.

Similar work, reported in Spath and Dayton (2003) shows that potential yields for Fischer-Tropsch fuels are between 0.075 and 0.2 L/kg per wet tonne of lignocellulosic biomass. Ethanol from thermochemical sources, as yet untested, could potentially be generated in the range of 0.145 L/kg feedstock. While fuels from thermochemical sources are not yet near commercialization, we considered the upper and lower bounds for F-T fuels in the same way that we considered figures for bioconversion.

Sustainable bioethanol production in Canada could be significant. In our estimates, we included the availability of residue generation from the wood processing industry as well as forest harvest residues and residues from agricultural production. In addition, energy plantations on marginal farmland were considered, for a variety of species.

### 3.2 Lignocellulosic feedstocks in Canada

Many studies have been conducted on the amount of residue or straw left behind in typical cereal agriculture. One North American study noted that the crop under consideration will dictate the total amount of residue left behind, with residues of 36, 23 and 18 kilograms produced per bushel of wheat, barley, and oats respectively (Shanahan et al. 1999). These figures can be converted using standard crop densities to show that total straw production is in the order of 1.3, 1.0 and 1.2 tons per ton of wheat, barley and oats respectively (Bowyer and Stockmann 2001).

It must be noted, however, that the amount of straw that can be removed and utilized in an industrial process is significantly lower than these figures indicate. It should be assumed that soil conservation requirements will account for between 50% or more of the total residues in many areas, and it may be expected that particularly dry conditions will result in mandating that 100% of residues remain on the field (Lindstrom et al. 1979, Shanahan et al. 1999). Furthermore, a proportion of straw will be utilized for livestock feed. Finally, variation in year-to-year crop yields will result in a reduction in residue production. After accounting for the factors of soil conservation, livestock feed and season variation, Bowyer and Stockmann (2001) suggested that only 15% of the total residue production would be available on average for industrial purposes. This report utilizes this figure in estimating available agricultural residues.

Based on the assumptions described above and on agricultural production statistics provided by the Food and Agriculture Organization of the United Nations (FAO 2006a), estimates of total agricultural residues were created for North America. These estimates are shown in Fig. 3-1. The shading illustrates the amount of available residues from total cereal production for each Canadian province (as well as for the US). The size of the circles on each province increases logarithmically with total potential 2<sup>nd</sup>-generation biofuel production, as indicated in the legend.

**Fig. 3-1: Availability of lignocellulosic agricultural residues**

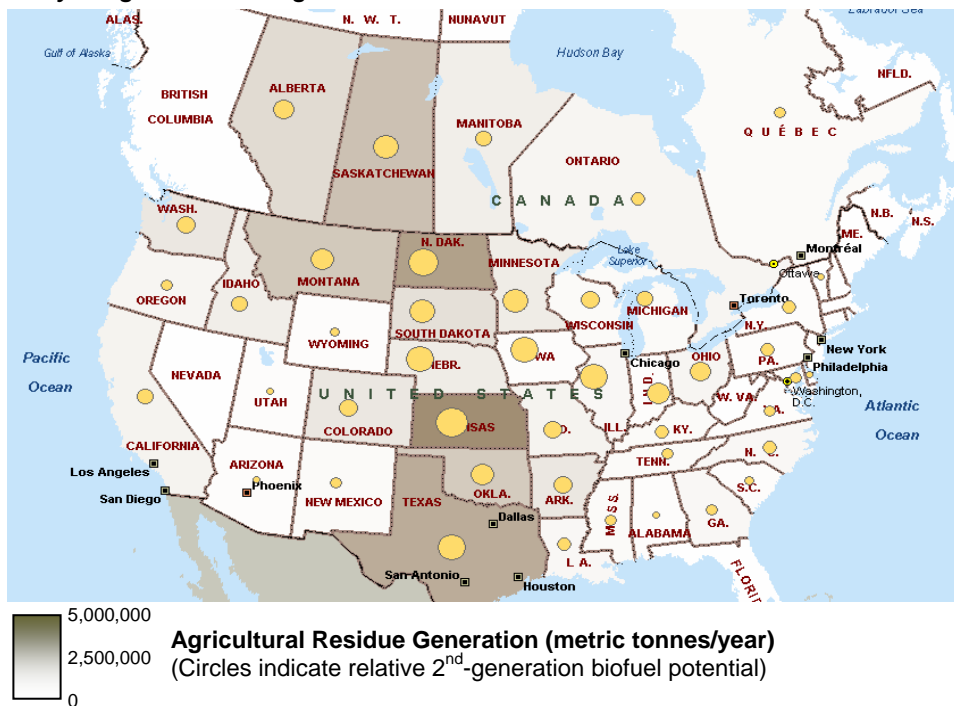

Lignocellulosic-based biofuel facilities will have access to a much greater variety of feedstocks than their industrial counterparts in the sugar- or starch-based sectors. In addition to agricultural residues, wood residues from forestry or forest product processes will also be suitable feedstock for the industry. In order to identify future locations for the growth of the industry, data on forest residue availability was examined.

The Food and Agriculture Organization of the United Nations (FAO) tracks forest residue generation on a national basis through a voluntary program of statistical reporting. Countries that have engaged in this process include Canada in North America, and most European nations including Sweden, Germany, and France. The available statistics describe two categories of residues. One category is the generation of residual chips and particles, which are utilized in the creation of value-added products including particleboard, oriented strand board and paper products. The second category is the generation of other wood residues, which include industrial remainders from both forestry and forest products processing (FAO 2002b). Other residues may be generated in the forest, but are not included in the current study. As with agricultural residues, the environment itself will place some restrictions on the total amount of residue that can ultimately be retrieved from forest operations. The issues of biodiversity conservation and soil and water protection will ultimately limit residue removals (Skog and Rosen 1997).

For countries that have not provided measures of wood residues to the FAO, estimates were created using average generation rates from countries where data existed. An effort was made to match nations with similar forestry and forest industry practices. Accordingly, an estimate for the United States was created using average generation rates from Canada. The estimates of forest residue availability are shown in Fig. 3-2. The total residue generation is illustrated by shading in each individual province and state. The circles illustrate the estimated ethanol production associated with these residues. The residues that are reported include waste from logging operations as well as from the processing of wood and paper products (FAO 2002b).

As shown in Fig. 3-2, estimates of provincial and state forest residue availability have been developed for North America, based on subnational forest removal and processing data in combination with reported national rates of residue generation. In Canada, it was possible to construct estimates on a provincial basis (CCFM 2003). In the United States, estimates are made at the forest region level.

These estimates of subnational residue generation were made by applying a weighted distribution, based on state or provincial forest production levels, to national generation rates.

It is recognized that subnational estimates of wood residue availability used in this report are likely inaccurate to some degree, due to the variation that is observed within the forestry sector over changing forest types and jurisdictions. These estimates may be used effectively to examine relative differences in total residue availability, however, and are thus intended to reflect relative differences in waste generation rates rather than accurate estimates of total residue availability.

**Fig. 3-2: Availability of lignocellulosic forest residues**

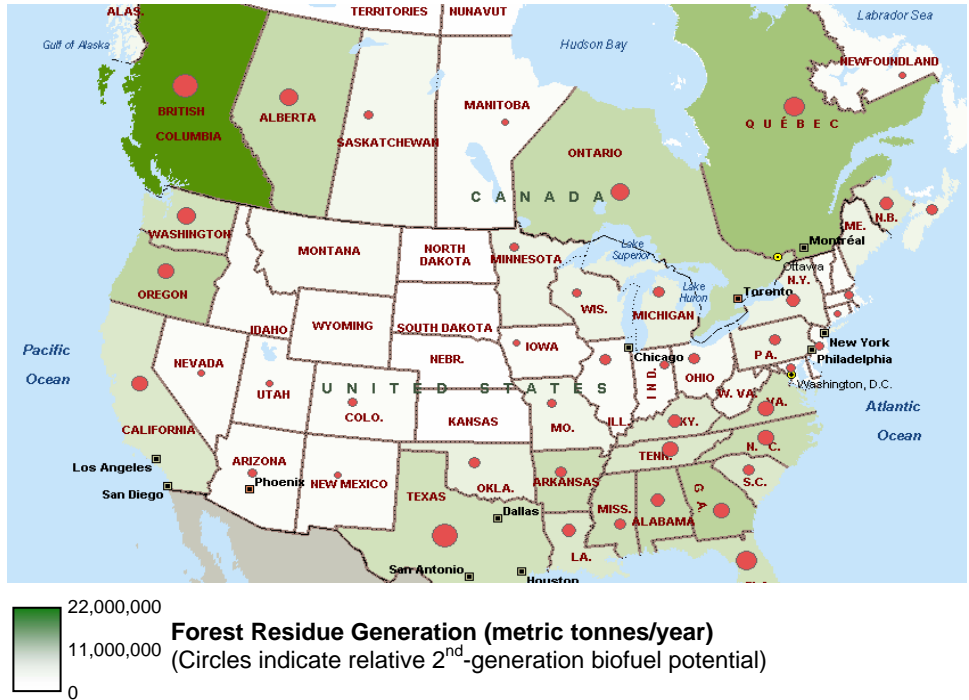

## 4 Scenarios:

### 4.1 IPCC Scenario interpretation

#### 4.1.1 Background

Scenarios of future biofuel production were designed for this project by adapting the emission scenarios developed by the Intergovernmental Panel on Climate Change (IPCC). Scenarios developed for OECD countries, as published in the Special Report on Emissions Scenarios (IPCC 2000), were examined and applied specifically to the Canadian situation. Special attention was played to the marker and illustrative scenarios chosen by the IPCC to serve in dialogue with scientists and policymakers.

The IPCC has arranged their emission scenarios into four families. The first family, A1, describes rapid and successful economic development. Energy resources are abundant, although the mix of renewable and non-renewable resources that are utilized varies significantly. There is an anticipated switch from "conservation" of nature to active "management" of natural and environmental services, which may be representative of a future in bio-based energy, materials, fuels and chemicals are widely used. Within the A1 family, three different approaches are illustrated. The A1T group of scenarios examines a world in which new technologies enable economic development, while the A1FI group focuses on a fossil-intensive basis for growth. The A1B group considers a balanced approach. In the A1 family of scenarios, a common element is that regional differences are predicted to diminish, and the gap between developing and developed countries will close. The A2 family, by contrast, represents a world in which regional differences are reinforced by lower trade flows, and where slower technological change means that some of the potentials in terms of bio-based products may not be realized.

The B1 family essentially explores a world where more sustainable development becomes the norm. It is anticipated that combined efforts of government, businesses, the media, and the public will be directed towards environmental and social issues related to development. Technological change plays an important role here, but with greater emphasis on achieving environmental goals than in A1T. As in the A1 family, regional differences are expected to diminish under these scenarios. The B2 family may be the most 'neutral' approach to modelling the future. As with the A2 family, these scenarios examine a world in which regional differences remain strong. Human welfare, equality, and environmental protection all have high priority, but where the implementation of social and technological solutions varies across regions.

For each scenario family, a 'marker' scenario was chosen. These scenarios do not represent a more likely future, but rather were selected as illustrative of the overall storyline. While originally only four marker scenarios were used, 'illustrative' scenarios were chosen for the A1T and A1FI groups within the A1 family because of the interest shown in the possible futures that they represent. We have chosen to utilize the full range of scenario outcomes, but we highlight the marker and illustrative scenarios.

### 4.1.2 Rationale

The IPCC emission scenarios were chosen for this project for a few reasons. They represent scenarios of the future that have achieved widespread consensus in the scientific community. The scenarios are commonly referred to in the scientific literature and in policy, and thus are a good reference point for a broad selection of anticipated readers of this report. Finally, the scenarios are very diverse and represent a wide range of potential outcomes over the next century, which makes them an effective tool for scientists and policymakers.

### 4.1.3 Approach

The first step was to examine each scenario and particularly the role that biomass-based energy was expected to play within the scenario. The SRES models that have supplied this figure (as discussed in IPCC 2000) take into account a number of underlying trends in social and economic data, including population and GNP/GDP. The models then adapt these trends according to the four storylines, and investigate the impacts of changing social priorities and technological capabilities on resource use (and ultimately greenhouse gas emissions). In Fig. 4-1, the anticipated role of bioenergy as a percentage of total primary energy supply is shown.

The range of biomass-based energy use in the future may extend from almost zero, considered in the B2 scenario as run by the MARIA model, to about 27% of TPES (as predicted in the B1 scenario, run by the MESSAGE model). The orange shading represents the full range of outputs from a variety of models across the range of scenario families. Note that the different scenarios tend to cross one another at different points, and that the highest and lowest reference points are widely divergent by the year 2100.

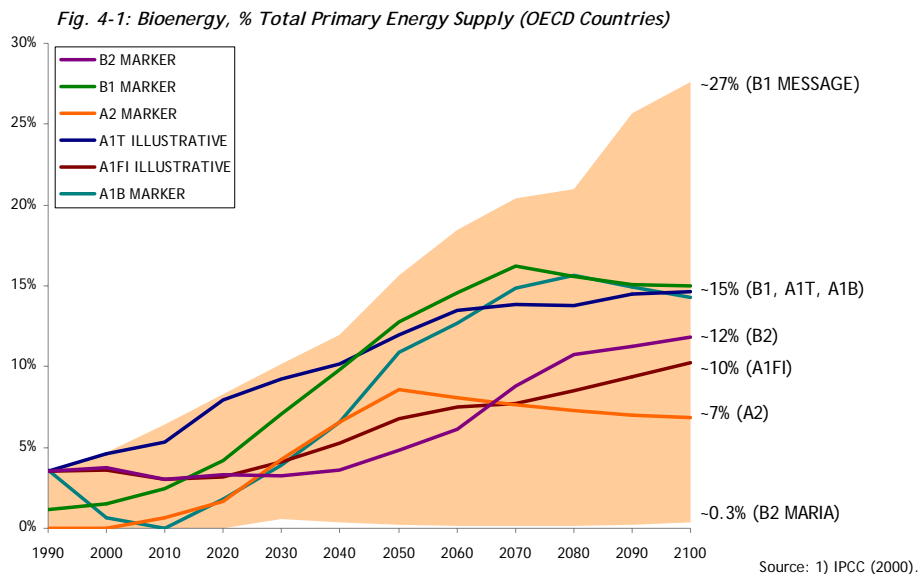

Not surprisingly, the B1 scenario ranks the highest of the marker scenarios, predicting 15% of TPES to be biomass-based by 2100. Even the more fossil-intensive futures (A1F1, A2) predict 7-10% biomass-based energy. In Canada, as of 2003, about 4.5% of our TPES is based on combustibles, which includes some waste materials (IEA 2003). This means that Canada fits within the range that the models predict.

After determining the rise in bioenergy relative to TPES, the second step was to identify the predicted range in absolute TPES for the OECD group of countries over the lifetime of each scenario. By doing so, the estimated increase (or decrease) in TPES, as calculated by the IPCC models, can be evaluated. Total primary energy supply for the OECD countries is modelled in Fig. 4-2.

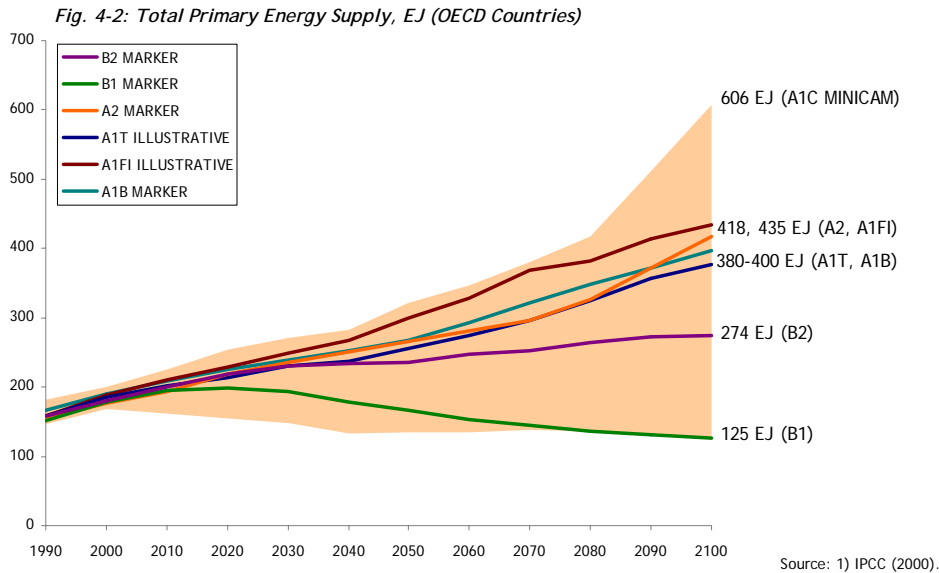

As shown in Fig. 4-2, the IPCC scenarios estimate TPES in OECD countries to range between 85% and 333% of 1990 levels. The A1 and A2 families predict the higher increases in energy supply, reflecting the dominance of economic development in these models. The B1 marker scenario is one of the few to actually predict a drop in TPES, again reflecting the strong environmental message embodied within this scenario family.

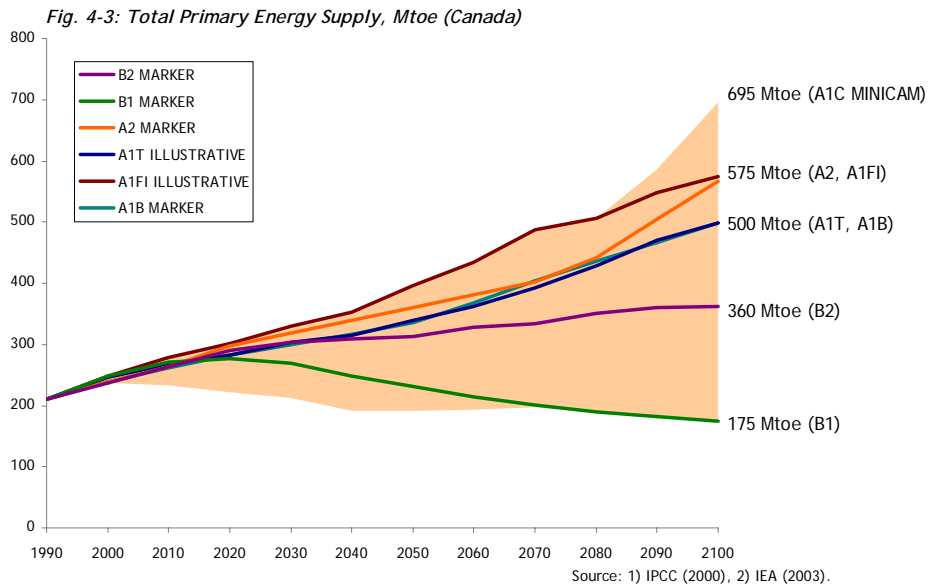

The third step in the modelling approach for this project was to apply the IPCC scenarios in order to predict the Canadian situation over the next 100 years. A baseline level for TPES was established using data from the International Energy Agency (IEA), who reported that Canada's total primary energy supply rose from about 210 Mtoe in 1990 to 261 Mtoe in 2003 (IEA 2003). Using this information and the trends shown in Fig. 4-2, TPES was modelled for Canada as shown in Fig. 4-3.

According to the application of IPCC models to the current Canadian situation, it is most likely that TPES will rise significantly in the next one hundred years. The B2 case, which is closest to neutral, would still see a rise of about 100 Mtoe, mostly over the next 20 years before levelling off. The other scenarios in the A1 and A2 families closely follow this trend, but continue to rise for the full forecast period, while the B1 family tends to trend downwards after the first two decades.

The final step in the modelling process was to predict the amount that biomass would contribute to primary energy supply, as defined by each of the marker and illustrative scenarios. This is shown in Fig. 4-4.

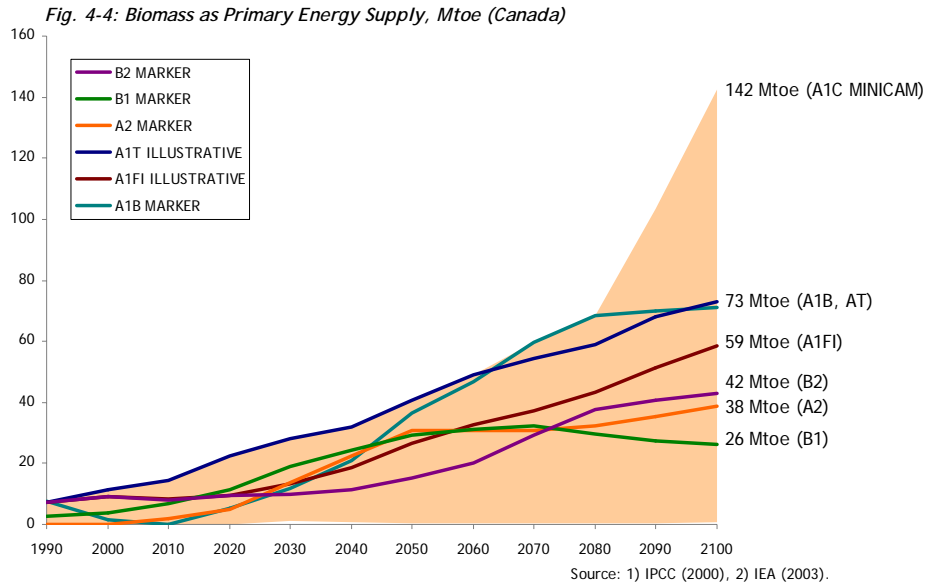

This figure illustrates the range of potential that biomass may play as part of our primary energy supply over the next one hundred years. The scenarios of biomass-derived energy that are shown by the marker and illustrative scenarios are used as targets for biofuel production.

#### 4.2 IPCC Scenario Application

Having determined the amount that biomass will contribute to primary energy supply, it was possible to apply the IPCC scenarios to Canada. For the sake of the argument, an assumption was made that biofuel consumption might follow similar trends to use of biomass in the total primary energy supply. Thus, in every scenario, commercial use of 2<sup>nd</sup>-generation biofuels in Canada will rise from zero (as in the present day) to levels determined by the scenarios, following the trends shown in Fig. 4-4.

The amount of 2<sup>nd</sup>-generation biofuel available will also be controlled in part by the amount of lignocellulosic feedstock that is available, which is primarily derived from agricultural, forest, and energy crop production. In each case, we considered the general trends defined by the IPCC scenarios for OECD countries, and then applied these trends to the Canadian situation. For example, anticipated changes to productive cropland area are shown in Fig. 4-5. Note that different scenarios interpret the proportional amount of 'starting' cropland differently, and that marginal farmland is not included. Based on these scenarios, an assumption was made for our model that the percentage of cropland in Canada would remain constant over the next 100 years.

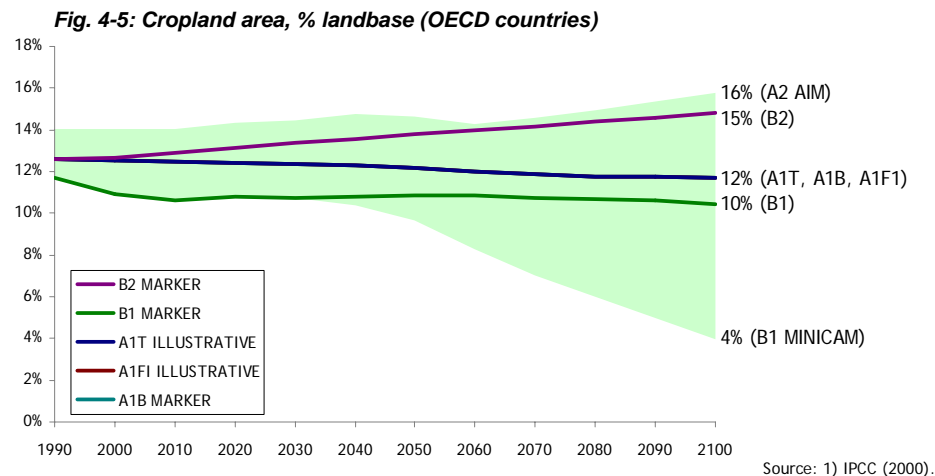

The average forested area for OECD countries is shown in Fig. 4-6. Most scenarios predict that the forested percentage of the overall landbase will remain constant, or increase over the next 100 years. In the most 'green' future, significant conservation efforts might raise the average forested area by as much as 25%, presumably on marginal agricultural land not included in the 'cropland' category. An assumption was made that, in Canada, the productive forest area will remain constant over the next 100 years, although additional forest area may be added to the protected landbase.

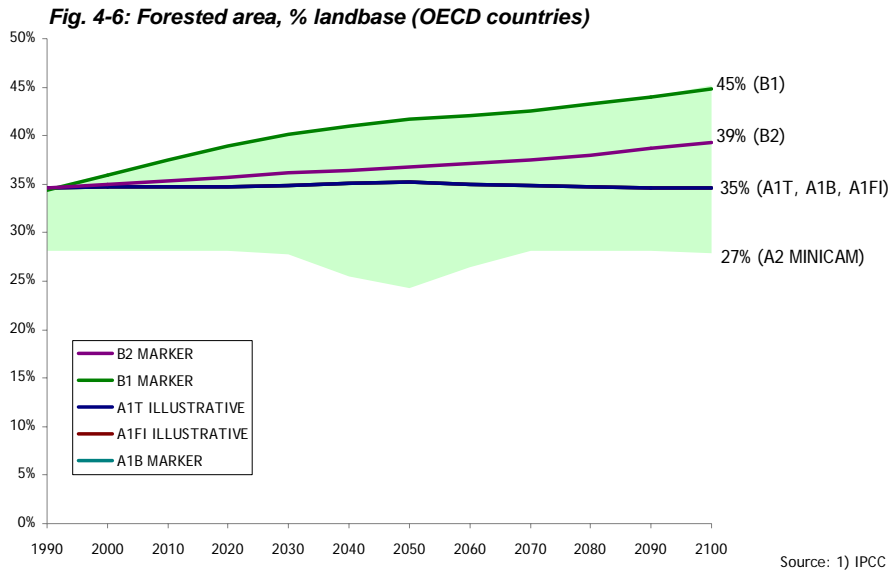

The total area of energy crops will rise significantly in most scenarios. In Canada, this will mean the addition of a new lignocellulosic feedstock source, consisting either of a perennial crop like switchgrass, or a short-rotation forest such as poplar or willow. For this potential source of lignocellulosic feedstocks, general OECD trends were applied to the total area of marginal farmland in Canada, estimated conservatively to be 140 million ha (Environment Canada 1992; Statistics Canada 2000, 2004). Based on the marker and illustrative scenarios, the likely establishment of energy crops in Canada will peak at around 30 million ha around 2080, a reasonable assumption as these would only occupy about 22% of the total marginal agricultural land area. The tendency of the predicted curves for the marker scenarios to tail off at the end of the forecast is an artefact of the modelling exercise.

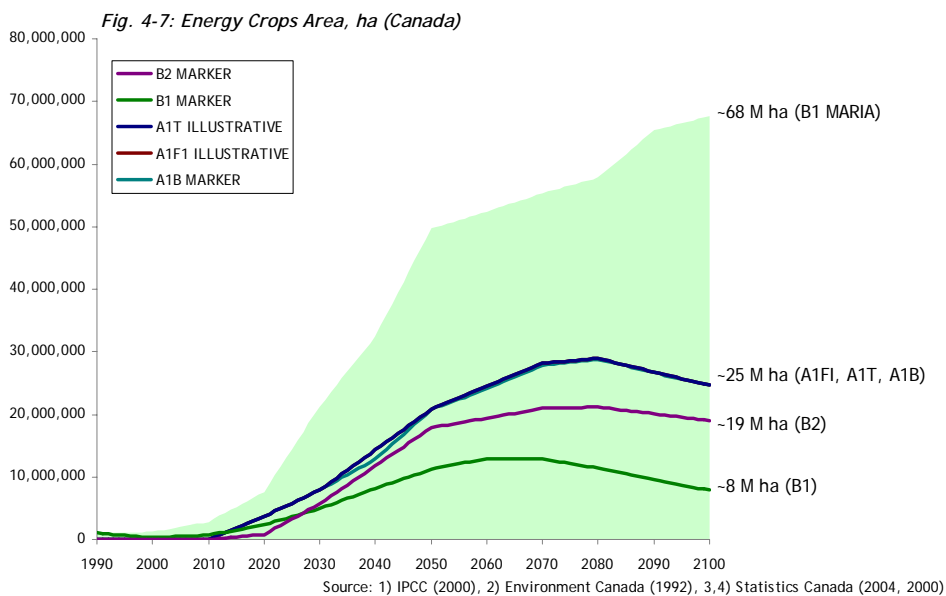

## 5 Discussion

### 5.1 Model outcomes

As described in the previous section, the application of IPCC scenarios to Canadian biofuel and bioenergy use has provided us with a range of future options for the uptake of biofuels, within the context of Canadian energy use. In Fig. 5-1, scenarios of expected consumption of refined petroleum products for Canada are presented.

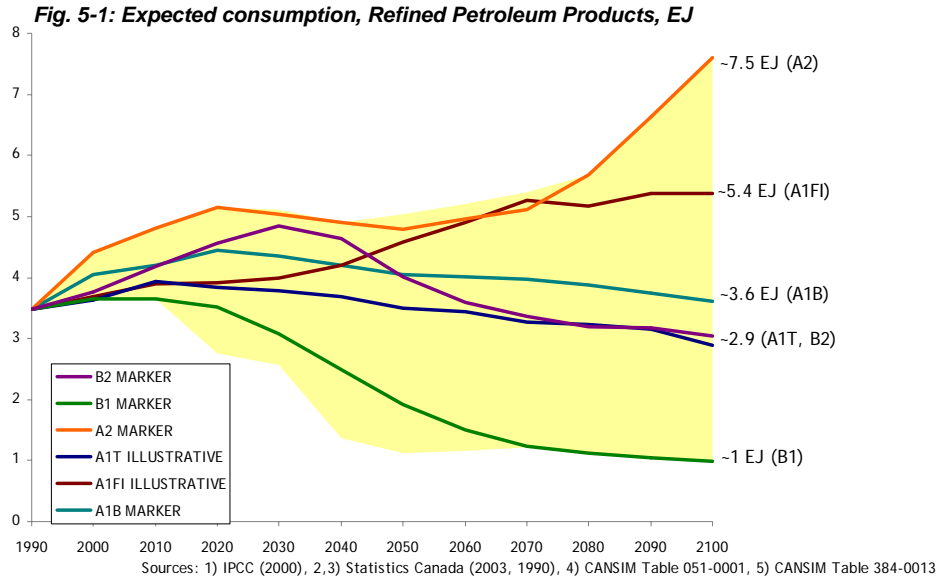

As the figure clearly illustrates, our choices and decisions over the next century will greatly impact consumption of refined petroleum products, including gasoline and diesel. In some scenarios - notably the A2 marker and the A1FI illustrative - petroleum use goes up tremendously. Slow technological change (A2), or continued reliance upon fossil fuels (A1FI), are both factors that would keep biofuel use at a relatively low level. However, the figure also shows that some scenarios include a reduction in demand for refined petroleum products. An environmental future (B1) would give us the greatest reduction, but application of technology (A1T, B2) or even choosing a more balanced future (A1B), where renewable energy is coupled with fossil applications, would maintain or lower consumption of RPPs over time. The A1T scenario is particularly interesting because it follows a relatively low upswing in RPP use before demand begins to decrease.

Demand for refined petroleum products will heavily influence the actual use of biofuels, as in most cases the two will be sold in blends of varying proportions. Thus, in the greenest possible futures such as the B1 scenario, the actual use of biofuels may not rise to a great extent because the overall use of liquid fuels will have declined. In more realistic scenarios, however, such as the A1T or A1B, the proportion of biofuels that is taken up will likely be much more significant, as the demand for liquid fuels will remain strong.

The full range of scenarios were applied to biofuel use as described in the previous section in order to determine the potential range of contribution that biofuels might have in Canada over the next century. This exercise is shown in Fig. 5-2.

Fig. 5-2: Biofuel Scenario Outcomes, EJ (Canada)

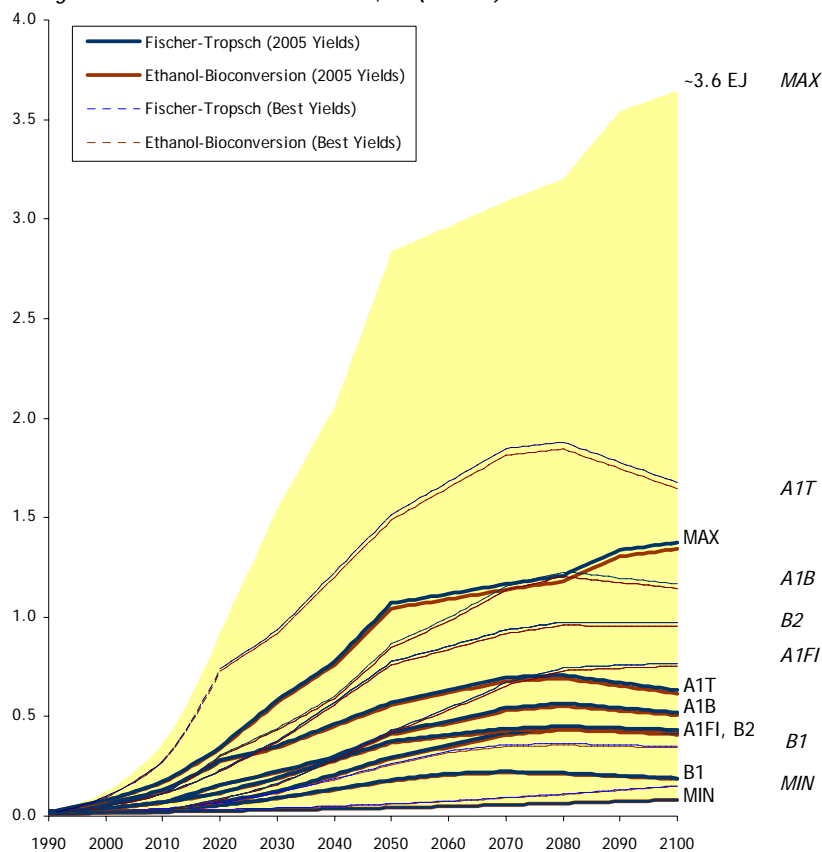

Sources: 1) IPCC (2000), 2,3) Statistics Canada (2003, 1990)

One interesting outcome of the model is that the overall potential contribution - in terms of energy - that may be derived from Fischer-Tropsch fuels is very close to lignocellulosic-based ethanol for the full range of scenarios. Ethanol provides 23.4 MJ/l produced; the estimated production from bioconversion is between 120 and 320 litres per wet tonne of woody material. Fischer-Tropsch fuels provide approximately 48 MJ/kg, which is approximately 37.6 MJ/l. It is possible to produce between 60 and 159 kg/tonne of Fischer-Tropsch fuel per wet tonne of lignocellulosic biomass. The higher energy yield of FT fuels is therefore balanced by a relatively low yield per tonne of biomass. Thus, the various scenarios used in the model indicate that both types of 2<sup>nd</sup>-generation biofuel have the ability to make similar contributions to the transportation fuel sector.

The model provides an overall range of potential 2<sup>nd</sup>-generation biofuel production in 2100 that is quite large. This range extends from about 0.1 EJ (the equivalent of about 2.2 billion litres of fuel annually) to about 3.6 EJ (about 45.2 billion litres annually). NRCan has estimated the demand for refined petroleum products for transportation to be about 2.6 EJ in 2005 (NRCan 2000), so the results of our model may be taken to describe a range between 4% and 139% of 2005 petroleum demand.

The marker and illustrative scenarios describe a more precise range of 2<sup>nd</sup>-generation biofuel availability. The A1T scenario, for instance, describes a technology-intensive future. In this future, we predict that the contribution of 2<sup>nd</sup>-generation biofuels will range between 0.6 and 1.7 EJ, depending upon the yield that the technological platform can provide. The total demand for refined petroleum products (RPPs) in this type of future, as shown in Fig. 5-1, is approximately 2.9 EJ. Thus, the overall contribution of 2<sup>nd</sup>-generation biofuels in a technology intensive future could be between 20 and 60% of total transportation fuel demand. By comparison, in a 'green' future, as described by the B1 scenario, the total demand for RPPs could drop to approximately 1 EJ. The contribution of biofuels in this future ranges between 0.2 and 0.35 EJ, or between 20 and 35%. A future with intensive fossil fuel use, as described by the A1FI scenario, would see demand for RPP rise to about 5.4 EJ, with biofuels making a contribution of between 0.4 and 0.75 EJ, or between 7 and 14%.

## 5.2 Meeting Canada's GHG commitments

The environmental benefits of 2<sup>nd</sup>-generation biofuels are primarily related to their ability to reduce greenhouse gas emissions, while providing a sustainable and renewable transportation fuel. The potential of these fuels to provide environmental benefits are thus related to the extent to which biofuels are utilized, which have been explored in the model described in the previous section. Estimates of GHG emissions for different fuels were obtained as discussed in Section 2.

In Fig. 5-3, the full range of estimated annual greenhouse gas emissions that would be associated with 2<sup>nd</sup>-generation biofuel use is described, for ethanol derived from bioconversion, and for Fischer-Tropsch fuels as a stand-in for biosyn diesel. Three time horizons are considered: 2010, 2050, and 2100. The yellow band describes the marker and illustrative scenarios (as set by the IPCC and adapted for this paper). The lines within the yellow region indicate the position of each scenario within this band (marked for reference sake in the 'Ethanol 2050' case). The white bands on either side of the yellow region indicate the absolute maximum and minimum extremes to which the full range of scenarios predict biofuel use in Canada.

The GHG emissions that are described can be simplistically considered as 'avoided' emissions, as they have a renewable origin and will be recaptured by the forest or energy crop from which they will be derived. This is not a perfect analogy, as the graph does not take into account the fossil fuels that may be burned in harvesting, processing, and distributing these fuels. Ethanol-dominated futures have higher GHG emissions than do scenarios examining Fischer-Tropsch fuel use, which is to be expected because Fischer-Tropsch fuel use is associated with lower emissions. Of the marker or illustrative scenarios, the A1T scenario is associated with the highest emissions, while the B1 scenario provides the lowest, as shown in Fig. 5-3. The maximum level of 'avoided' emissions associated with any future is about 50 megatons of CO<sub>2</sub>-equivalent per year.

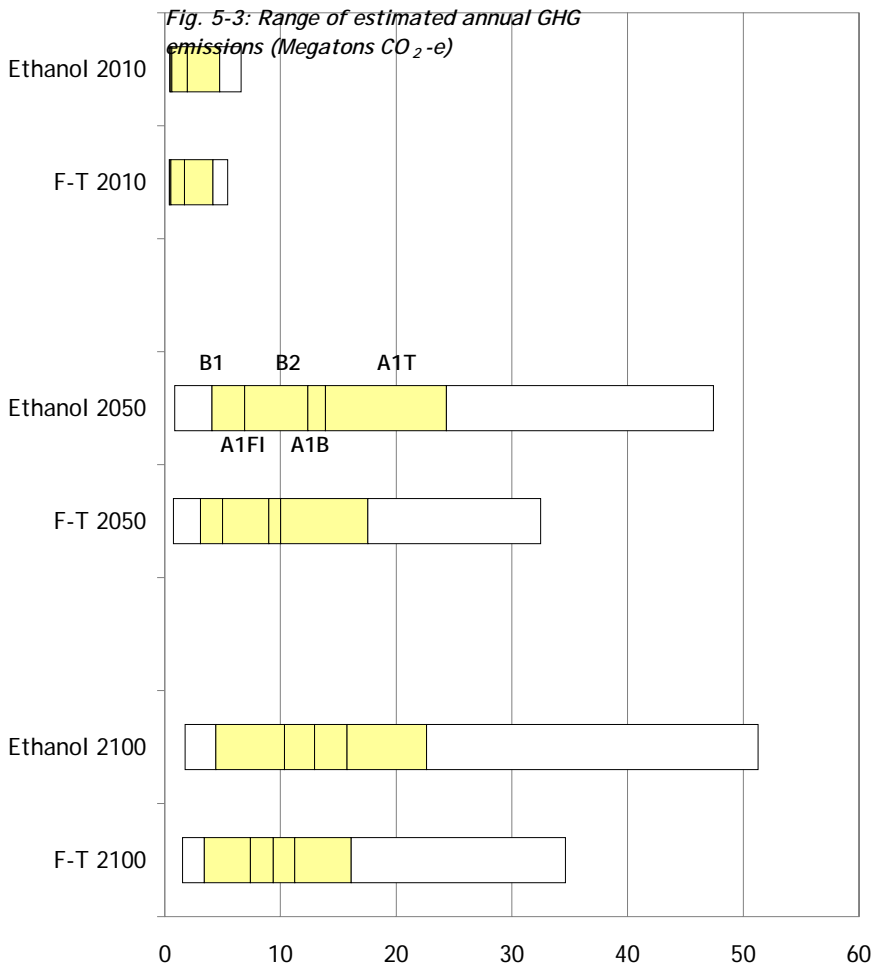

In Fig. 5-4, the range of estimated savings in annual greenhouse gas emissions associated with bioconversion-based ethanol and Fischer-Tropsch fuels is shown. This savings is calculated by using each scenario to calculate total GHG emissions that would be reached with conventional fuels, and comparing these totals with the emissions that will be achieved with different levels of biofuels. Ethanol is compared with conventional gasoline, while Fischer-Tropsch fuels are compared with conventional diesel. The emissions associated with conventional fuels are based on the '>2010' estimates of improvements to fuel production, as provided in Fig. 2-4.

Based on our model, ethanol provides the greatest potential savings in terms of percent reduction in GHG emissions over conventional fuel use. This is because gasoline is associated with higher emissions than diesel, which means that replacing a portion of gasoline with ethanol will result in a greater percentage of avoided emissions. Thus, in a country where gasoline is intensively used - like Canada - ethanol has the potential to make a significant reduction in GHG emissions.

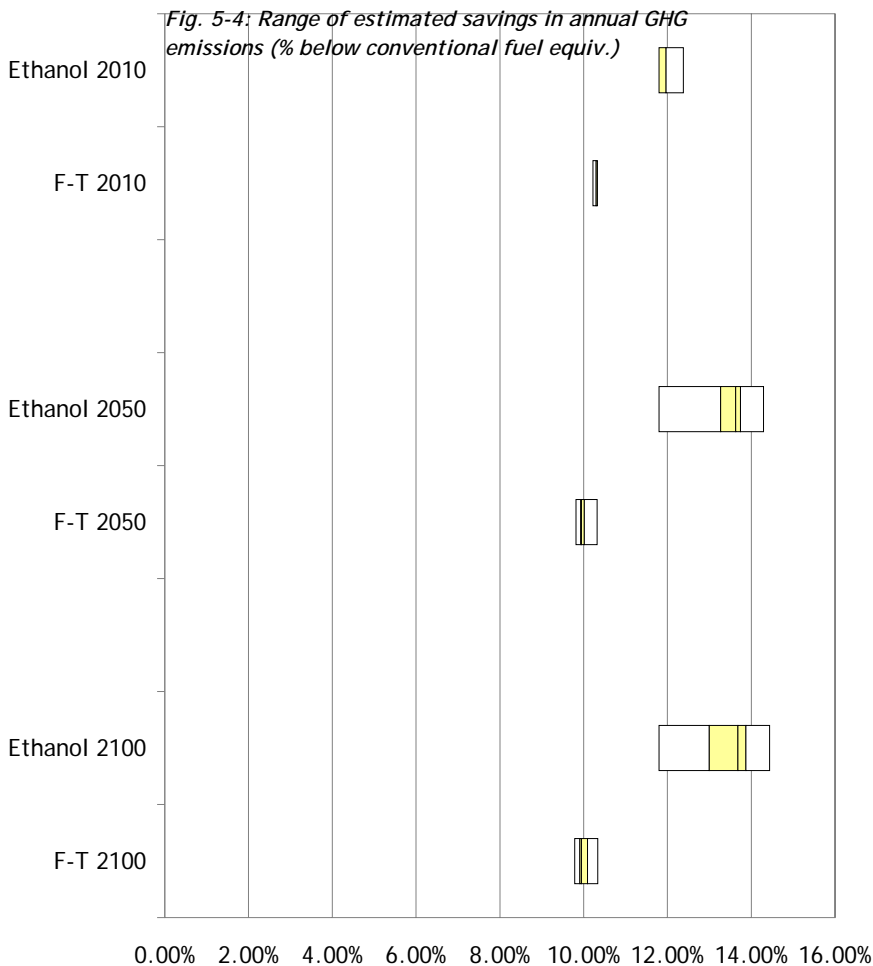

### 5.3 Economic and social implications

Introducing 2<sup>nd</sup>-generation biofuels will create a number of new job opportunities. The processing facilities required to convert biomass into value-added products create direct and indirect jobs, provide regional economic development, and can increase farm and forestry incomes, particularly in rural areas (4,5). As an example, bioethanol generation in the US has created an estimated 200,000 jobs and \$500 million in annual tax receipts (4), which has led to the investment of more than \$1 billion (US) over the past decade towards biorefinery research. The potential for Canadian business is similarly positive.

In the US, most experience has been with 1<sup>st</sup>-generation starch-to-ethanol biofuels, using the bioconversion platform. These facilities have typically been constructed on scales between 50-200 litres per year of ethanol production ((S&T)<sup>2</sup> 2004). Similar plant sizes have been proposed for 2<sup>nd</sup>-generation bioconversion-based ethanol plants. A typical mill might be 170 million L/a, consuming between 530,000 and 1.4 million tons of feedstock, depending upon the efficiency of conversion. If it were able to appropriate 100% of the growth in the area surrounding such a facility, the 'footprint' of such a facility would be as illustrated in Fig. 5-5. Because most of these facilities will be based on residues, it is likely that real transport distances for residues may be increased. For example, if only 10% of feedstock harvest goes towards 2<sup>nd</sup>-generation biofuel production, the radius of the feedstock catchments would increase by a factor of 10.

Fig. 5-5: Estimated feedstock catchments, bioconversion platform

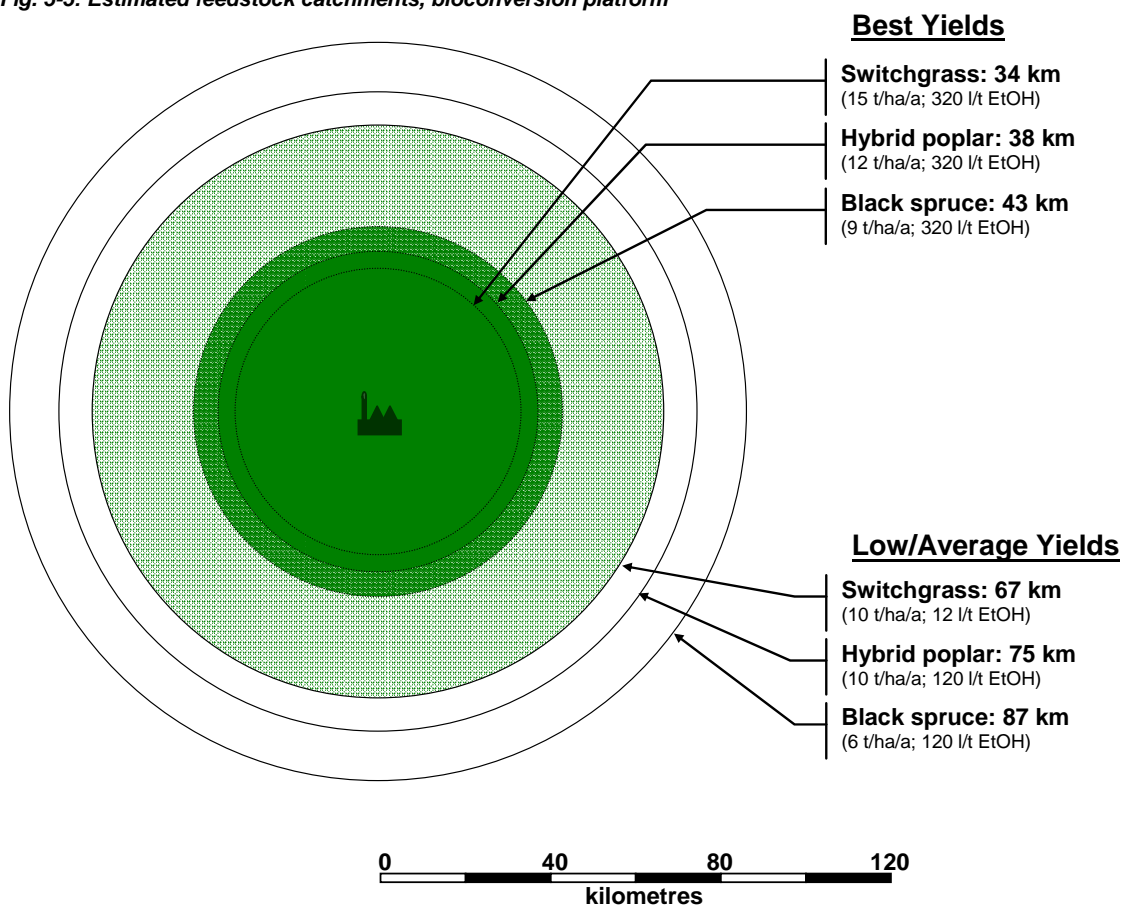

Most experience with the thermochemical platform for fuel production have been based on coal or natural gas, and no good data is available for equivalent commercial biomass-based facilities. However, the scale of operations for fossil-fuel based thermochemical plants is much larger than with the bioconversion platform. For example, most gas-to-liquid facilities are built with capacities between 1 and 3 billion litres per year equivalent fuel (Cao et al. 2003). A typical mill might be 2.225 billion L/a, consuming between 12 and 29 million tons of feedstock, depending upon the efficiency of thermochemical conversion. If it were able to appropriate 100% of the growth in the area surrounding such a facility, the 'footprint' of such a facility would be as illustrated in Fig. 5-6. Again, it might be expected that most of these facilities will be based on residues, and so it is likely that real transport distances for residues may be increased by a factor of 10 or more. (Note that the equivalent catchments for a bioconversion plant are indicated at the bottom left of the figure by the green circles.)

**Fig. 5-6: Estimated feedstock catchments, thermochemical platform**

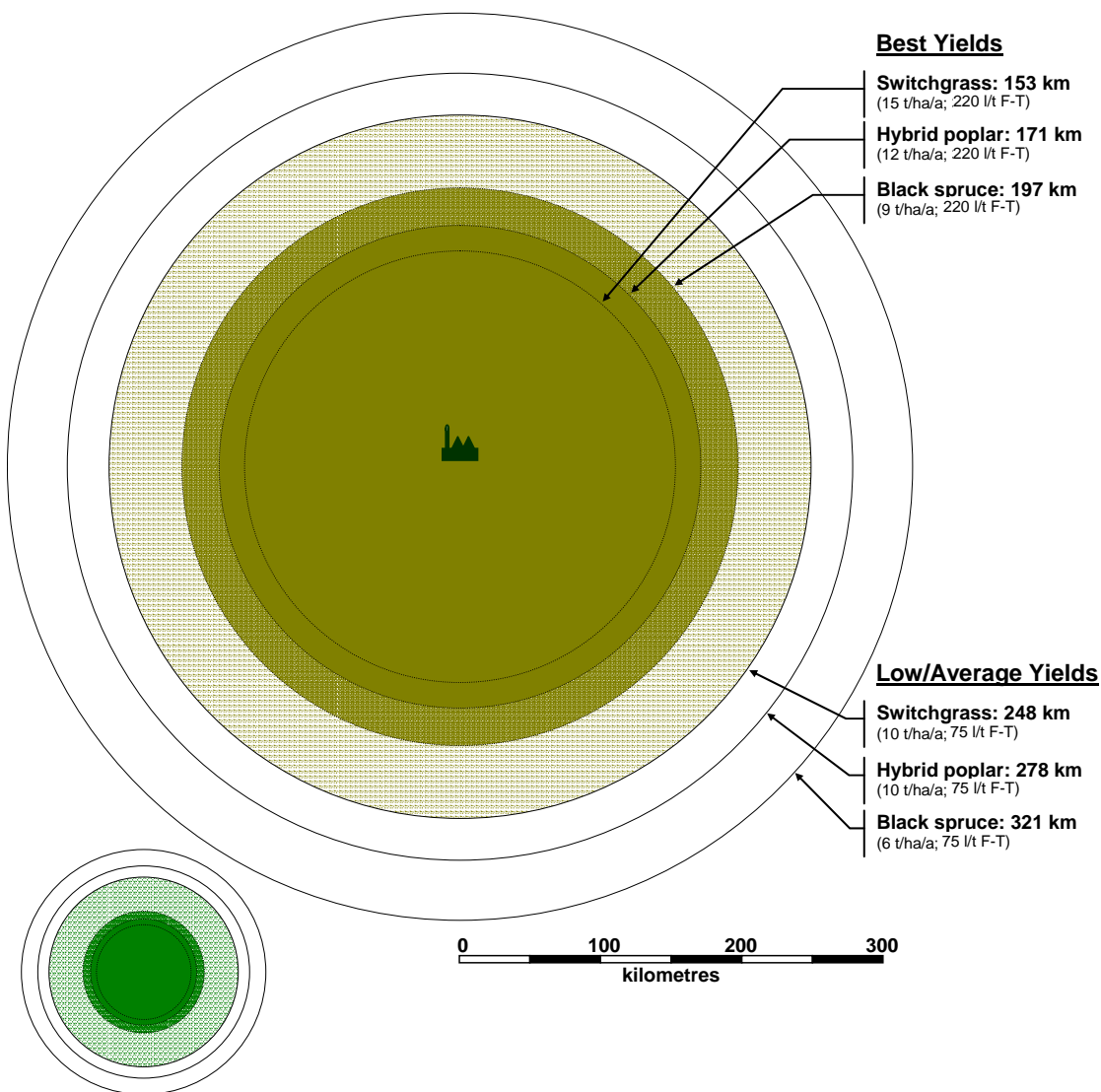

The implication of this is that the number of potential facilities for 2<sup>nd</sup>-generation biofuel production will be directly influenced by the choice of platform. Even if the size of thermochemical facilities may be reduced by half without losing process efficiencies, it would still be much larger than a typical bioconversion facility. This will in turn likely reduce the potential for direct employment associated with the thermochemical platform, when compared to bioconversion. At the same time, larger facilities will require a much larger feedstock, which will have to be sourced from further distances. This will increase the logistical complexity of operating these facilities in an efficient manner.

#### **5.4 Coproduct generation with thermochemical platforms**

One of the major implications of thermochemical-based scenarios is the ability to generate excess heat and power.

Bioenergy is a defining component of a biorefinery. Self-generation of heat and power by the combustion of a portion of biomass feedstock can offset fossil fuel requirements, displacing the load on utilities and improve the environmental performance of the facility. The forest products industry has typically viewed energy projects with some trepidation, as investment in energy production would take away from the core business of pulp, paper or wood product manufacture. Because of this, the industry demands a much higher internal rate of return on their energy-related investments than do electrical utilities. However, the cost of buying natural gas to generate heat and power internally has risen dramatically. In June 1996, the cost of natural gas was about \$1/GJ (CDN currency), but by 2005, the average price has risen to about \$7/GJ (NRCan 2005a). Electricity costs have risen as well, increasing self-generation as a viable alternative.

In the pulp and paper industry, today's Kraft pulp mills effectively use biomass residues contained in black liquor to generate heat and power through recovery boilers; biomass is estimated to contribute more than 50% of total fuel use by the pulp and paper industry in both the US and in Sweden (Farahani et al. 2004). The evolution of pulp mills towards biorefining might include upgrading recovery boilers with thermochemical technologies under development, including fast pyrolysis and gasification (BRDTAC 2002a). Other options for improved energy production include co-firing or cogeneration (i.e. combining biomass with fossil fuels in combustion). It is estimated that gasification technology has the potential to generate approximately twice as much electricity per ton of black liquor as a conventional recovery boiler (Farahani et al. 2004, Larson et al. 2000). This additional power can reduce the need to purchase natural gas, coal, oil and electricity for everyday operations, increasing the economic performance of the facility.

The rising cost of energy today has increased the impetus for the pulp and paper industry to move towards 100% self-generation of power. It has been estimated that one tonne of softwood lignin embodies between 22.2-23.5 GJ of energy (LHV/HHV) (ECN 2005). This means that one dry tonne of lignin can be worth approximately (\$7\*22.2) or \$155/tonne in energy value to a mill that currently utilizes natural gas, up from \$22/tonne in 1996. Using standard net heating value for wood (Dietenberger 2002), it can be estimated that at 50% moisture the value of lignin remains high, at about \$140/tonne. At this value, self-generation of heat and power for in-mill use may be economical, even given the predilection of the wood products industry to view energy projects as outside their mandate. There is some government support for investment in more efficient self-generation technology. For example, the Renewable Energy Deployment Initiative (REDI), introduced by Natural Resources Canada in 1998, can be used to offset 25% of purchase and installation costs of biomass energy systems, up to a total of \$80,000 (CDN) per installation (Bernotat and Sandberg 2004).

Excess heat and power can be utilized for additional value-added processing, or can be distributed through a local network to provide district heating of nearby businesses and residences (NRCan 2006). The potential appeal of bioenergy as a product may be limited, however, by the regulatory regime which governs electricity generation, transmission, and sales. Two Canadian provinces, Alberta and Ontario, have been considering deregulation of the electricity industry, but the negative experiences that some US jurisdictions have had with deregulation (notably California) may reduce the willingness of Canadian consumers to embrace a deregulated market. In Canadian markets today, energy generators are limited to wholesale transmission access, or wholesale 'wheeling', which allows them to sell energy to a utility. To do so, the generator must enter into purchase agreements with the utilities that provide power to consumers. For instance, the largest bioenergy generation facility in Canada, the Williams Lake Cogeneration facility run by Terasen, has a 20-year purchase agreement with BC Hydro. Typically, each agreement is negotiated individually. Green power incentives, such as the recently introduced Renewable Power Production Incentive (RPPI), will pay an incentive of 1¢ per kilowatt-hour of production for the first ten year of operation for eligible projects, which include biomass projects (NRCan 2005b).

## 5.5 Coproduct generation with bioconversion

One of the major implications of bioconversion is its ability to support a number of value-added coproducts.

In the past, chemical products were a major part of the forest industry. A number of chemical forest products, based on extractives, were the basis of a thriving industry in North America from the early 1700's to the onset of World War II in 1939. These products included pitch (partially dried resins), pine tar (liquefied resins), turpentine (terpenes from distilled resins), rosin (the involatile residues from resin distillation). Later, tall oils (which were obtained from alkaline pulping liquors) added the naval stores category; tall oils could be fractionated into tall oil rosin and tall oil fatty acids. These products were widely used in wooden shipbuilding & operation, which lent this product category its name of 'Naval stores.' Today, a limited amount of forest-based naval stores are still produced and used to manufacture soap, paper, paint, and varnishes. While few up-to-date estimates of this industry exist, a review was carried out in the mid-1990's by the Food and Agriculture Organization of the United Nations (Coppen and Hone 1995). It was reported that about 1.2 million tonnes of rosin worth approximately \$400 million (US currency) was produced in 1995, a third of which was tall oil rosin based on sulphite liquor. In the same year, about 330,000 tonnes of turpentine was produced, totalling about \$50 million; two-thirds of this amount was turpentine recovered during Kraft pulping. The major producers of forest-based naval stores included China, India, Russia, Brazil, and Portugal at the time of the report (Coppen and Hone 1995).

Today, there is a resurgence of interest in renewable biochemicals as a means of reducing our reliance upon petroleum-based products. Research has shown that a number of the platform chemicals that supply advanced manufacturing may be generated from biological sources (Spath et al. 2003, Werpy et al. 2004). The chemical products that can be derived from the biorefinery have the potential to become a significant part of Canada's economy in the future. The potential Canadian market for industrial chemical bioproducts has been estimated at about \$1.7 billion/year (Canadian currency) (Crawford 2001, CANUC 2002). Health-related chemicals, which can include nutraceuticals, essential oils, pharmaceuticals, drugs, and medicines, have a potential Canadian market of \$260 million/year. Finally, niche products designed for bioremediation and phytoremediation of contaminated soils, as well as biocontrols designed to contain and control chemical spills, have a Canadian market anticipated to be \$50 million/year (Crawford 2001). In the United States, where biorefining efforts based on agricultural biomass are relatively advanced, significant work has been done by the Biomass Research and Development Technical Advisory Committee to define goals for bioproducts. These goals included tripling the amount of bioproducts consumed by 2010, providing benefits to farmers and forest landowners by increasing the value of agricultural and forest biomass, and reducing the environmental impacts of consumer goods through substitution and increased use of bioproducts (BRDTAC 2002a).

Biochemical development in the United States is largely based on sugars. As discussed earlier, sugars are one of the main intermediate products of the bioconversion platform. The report entitled 'Top value Added Chemicals from Biomass', produced by the Pacific Northwest National Laboratory and the National Renewable Energy Lab, identified candidate products, and specified if the necessary technology pathways were under development or commercially available (Werpy et al. 2004). A range of products, including sorbitol, furfural, itaconic acid, glutamic acid, xylitol/arabitol, and glycerol, are already produced commercially. A forest-based biorefinery based on the bioconversion platform could provide inexpensive sugars as feedstocks to these processes.

One of the emerging commercial opportunities for sugar-based biochemicals is in the area of bulk polymers. In the US, there are two major projects underway to produce bulk biopolymers, for use in textiles and packaging applications. One of these was launched by Cargill under the name Natureworks LLC, which produces two polymer products derived from polylactide (PLA). Polylactide is derived from lactic acid, which is generated from sugars through bacteria fermentation. The commercial products based on this polymer include Natureworks PLA, bulk packaging for the food and beverage sector, and Ingeo Fibre, a textile product that can be used in apparel and other applications

[50]. While these products are currently based on sugars derived from corn starch, the company is working with Genencor International and Iogen to expand their feedstock to lignocellulosics (DOE 2006g). A second major project has been undertaken by E.I. DuPont de Nemours & Co., in partnership with the Diversa Corporation. This consortium is developing processes to transform corn stover, a lignocellulosic feedstock, into glucose and then into 3-hydroxypropionic acid (3-HPA), which can be reduced into 1,3-propanediol (DOE 2006h). This is being processed into a polymer fibre by DuPont and marketed as Sorona Fibre. 3-HPA can also be dehydrated to produce a variety of acrylic products, including acrylic acid and acrylamide, which can then be used in products such as diapers. This polymer has unique properties, such as stretch recovery, resiliency, toughness, and easy dye capability. It can be manufactured in existing facilities. Cargill is also working on pathways to generate 3-HPA, in conjunction with Codexis and the US DOE (DOE 2006i).

Another area currently seeing development is the production of 1,4-diacids. For example, Bolak and Company are working on a US DOE-funded project to demonstrate the production of succinic acid in an ethanol dry mill, using ammonia fibre explosion (AFEX) pretreatment to process corn fibre and eventually switchgrass (DOE 2006i). The 1,4-diacids act as a precursor in many industrial processes, and could replace the benzene class of commodity petrochemicals. It can be used in the manufacture of butanediol, tetrahydrofuran, and pyrrolidinones, chemicals with application in plastics, paints, and inks. Other interesting derivatives of this product include lactate acid and ascorbic acid (vitamin C), which can be used in a variety of food products.

Monomers generated by the bioconversion platform may be converted through chemical means into levulinic acid (LA). This chemical is used as a building block in the manufacture of industrial products. Partial reduction of levulinic acid can lead to a fuel additive known as LA-methyltetrahydrofuran (MTHF), which could potentially have a large market in traditional or biofuels. Complete reduction of LA leads to 1,4-pentanediol, which could form the basis of new biopolyesters. Through oxidation, acetyl acrylates may be generated, which may be used to enhance the properties of other monomers. LA may also be converted into a herbicide known as delta-amino levulinic acid, which has a market of \$US 0.4-0.9 billion per year (Werpy et al. 2004, Crawford 2001). This bioproduct is well on its way to commercialization, with a 1-ton per day pilot plant constructed in New York State by the Biofine Corporation, in conjunction with NREL, PNNL, New York State, and Chemical Industry Services.

## 6 Conclusions

There are three separate yet complementary approaches to developing the forest-based biorefinery: (1) re-engineer existing pulp and paper or sawmill operations to create biofuels, biochemicals, or bioenergy as a coproduct to the traditional forest product; (2) re-engineer existing facilities, or develop new operations that can maximize bioenergy recovery, and develop downstream processing to generate biofuels or biochemicals; or (3) develop greenfield operations capable of delivering intermediate chemical products that may be further processed into biofuels, platform chemicals and bulk polymer applications, and bioenergy.

The first approach, adapting a modern pulp mill to act as a biorefinery, means utilizing a portion of mill feedstocks for alternative products, but also implies that the focus will remain on traditional forest products. Modern pulp mills are highly efficient and leave behind few residues that can easily be directed into biorefining operations. Perhaps the most obvious adaptation is the introduction of thermochemical platform elements to the Kraft pulping process for improved energy recovery from black liquor. Bioconversion process elements might be included as a pretreatment to the pulping process itself, where easily hydrolysable sugars are stripped away from the pulp in order to create a parallel feedstock to the traditional pulping technology, and perhaps improve the quality of the paper being produced. In older pulp and paper mills built on sulphite pulping technology, the absence of efficient liquor recycling provides an easily accessed feedstock for biorefining. In Canada, the Tembec facility in Temiscaming is an excellent example of the biorefinery concept being applied to an older facility. The problem with this type of approach is that process efficiency will be sacrificed, and the feedstock diverted to secondary products will not be optimal but instead will consist of residual, heterogeneous materials.

The second and third approaches may be differentiated from the first by the decision to make biofuels a dominant output of the biorefinery rather than a coproduct. These approaches consider the long-term evolution of Canadian pulping facilities towards more diverse biorefineries that are capable of producing energy, fuels, and chemicals, as well as a variety of material products.

In the United States and Canada, the bioconversion platform remains dominant today. A great deal of effort has focused on the production of ethanol from sugars, which may be derived from lignocellulose through the bioconversion platform. Since 1976, over 80 new ethanol production facilities have been built in the U.S. primarily using starch as a feedstock. The overwhelming majority of proponents in North American biofuel production have demonstrated expertise in the biological pathways of hydrolysis and fermentation. This availability of expertise is an important element of commercial success.

The bioconversion platform is rapidly approaching commercial deployment in the agricultural sector and has achieved demonstration status for lignocellulosics. An economical technology for bioconversion of lignocellulosic biomass would greatly extend the potential of the ethanol industry to become a substantial contributor to the fuel and energy requirements of Canada. The great advantage of the bioconversion platform is that it offers a means to generate sugars from lignocellulosics, which can act as feedstocks for a number of new biochemical products being commercialized today. A number of processes currently being demonstrated for different bioproduct generation in the United States could give this platform the ability to generate bulk polymers, textiles, food packaging, and nutraceuticals. This represents a radical departure from traditional forest products and brings a number of marketing and production challenges. Finally, the scale of operations for bioconversion facilities is closer to the typical size of a forest products mill, and provides an advantage for potential employment.

It is estimated that bioethanol from the bioconversion platform has the ability to offset a greater amount of greenhouse gas emissions than does thermochemical-derived fuels, but this is due to the nature of the conventional fuel that is being replaced, and the energy content of the biofuel. The percentage reduction in emissions associated with biosyn diesel is lower when compared to bioconversion-based ethanol. This is because ethanol is seen to replace gasoline, which in turn has higher inherent emissions. In terms of net greenhouse gas emissions, thermochemical-derived fuels have an advantage.

Major technical issues remain for the thermochemical production of 2<sup>nd</sup>-generation biofuels, including the quality of syngas, the accumulation of char, and inhibition of the catalysis stage. If these technical issues can be overcome, our models show that the widespread uptake of biosyn diesel could provide the greatest total GHG savings of all 2<sup>nd</sup>-generation biofuels. Because biosyn diesel would likely be offered as a blend with traditional diesel, this scenario relies upon increased traditional diesel use throughout Canada. A number of preliminary steps would be required, including revisiting existing taxation on traditional fuels. In terms of coproducts, the thermochemical platform is currently most effective at delivering energy, which may reduce operating costs for a mill significantly, but as a product may not offer high returns to the company in a regulated energy market. Finally, the potential for direct employment with the thermochemical platform may be smaller than with bioconversion, because of the likely need for large scale operations that can achieve process efficiencies.

An opportunity exists for the federal Canadian government, together with its provincial counterparts, to implement policy that supports lignocellulosic-based biorefining efforts, regardless of platform. In particular, national policy should be designed to complement provincial approaches, and to support biorefining initiatives using both technological platforms. There are many positive reasons to create this type of policy. Biorefineries based on lignocellulosics will be able to access a much wider variety of feedstocks, including forest biomass. Successfully doing so will increase security of supply and improve the ability of biorefineries to support a transition to a carbohydrate-based economy. The dependence of bioproducts upon specific feedstocks becomes less significant as the complexity of the process increases; thus, biorefineries that rely upon lignocellulosic material can utilize a more diverse selection of biomass. It is clear that no single biomass option can source the total Canadian demand for fuels and chemicals, and that different feedstocks and technologies will require significantly different policy approaches.

## 7 Recommendations

We identify six key policy recommendations for 2<sup>nd</sup>-generation biofuels, as listed below. These include general recommendations as well as comments related to specific fuels.

1. The design of a Canadian Renewable Fuel Standard (currently under discussion between Federal and Provincial governments) should anticipate the current contribution of 1<sup>st</sup>-generation biofuels, as well as the potential contribution of 2<sup>nd</sup>-generation biofuels. Federal funding of 2<sup>nd</sup>-generation biofuel programs should be separate from 1<sup>st</sup>-generation biofuels, and should be linked to development of biorefinery facilities. The technological platform should not be specified by policy, but should be guided by industry's assessment of technical capabilities, potential coproducts, and total economic returns.
2. All levels of government should consider a three-component approach to the development of 2<sup>nd</sup>-generation biofuel capacity in Canada:
  - a. Utilize existing models of government programs (i.e. the Ethanol Expansion Program) that can minimize the economic risk to investors associated with establishing 2<sup>nd</sup>-generation biofuel infrastructure in Canada.
  - b. Introduce an economic incentive for the production of biofuels, reflecting the origin of the biofuel (i.e. 1<sup>st</sup>-generation vs. 2<sup>nd</sup>-generation, bioethanol vs. biosyn diesel), and the costs associated with production, in the form of tax breaks or producer credits, and the potential for coproducts.
  - c. Introduce an economic incentive for consumer utilization of biofuels (or biofuel blends) the form of tax breaks or subsidy which translate to lower prices at the pump. It is important that this incentive be geared to the proportional blend, i.e. the higher the blend, the greater the incentive.
3. Where possible, the funding of 2<sup>nd</sup>-generation biofuel programs should be harmonized with renewable energy programs and other synergistic programs, such as rural employment and agricultural assistance programs, in order to maximize support for infrastructure development. This requires continuation of dialogue and collaboration between Ministries, and between the Federal and Provincial government equivalents. This activity may also help determine the optimum technological platform for specific applications.
  - a. In specific cases where there is an emphasis on development of the rural economy through alternative value-added commodity products, the bioconversion platform provides the best immediate opportunities for biorefining activities.
  - b. In specific cases where there is a requirement for bioenergy to meet demand for electricity or energy, the thermochemical platform offers the best immediate opportunities for biorefining activities.
4. It is important that all levels of government continue to provide funding aimed at addressing technical challenges and hurdles at all levels of research, development, and deployment of 2<sup>nd</sup>-generation biofuels.
  - a. This funding should include downstream creation of value-added chemical products and bioenergy generation.
  - b. This funding should continue to build strong linkages to the US, in order to build upon the advances that the agricultural and chemical sector in that country has made with the bioconversion platform.

5. In order to promote the use of both 1<sup>st</sup>- and 2<sup>nd</sup>-generation biofuels within Canada, governments should consider the following approaches
  - a. Increase awareness of available flexi-fuel vehicles through educational programs.
  - b. Develop policies to encourage distributors to offer a biofuel alternative at every pump, so that consumers have a high-biofuel option to utilize in flexi-fuel vehicles.
  - c. Open a dialogue between Federal and Provincial governments to consider a move towards the European model of fuel taxation, which creates an incentive towards diesel use by raising gasoline costs. Promoting diesel use is an essential first step towards increasing potential use of biosol diesel in Canada.
  
6. Establish a Centre for Innovation that brings together Canadian capacity in Biorefinery research, including, and involving government, industry, and university players. We strongly suggest that this Centre be housed in a Canadian University with expertise in commerce, engineering, biotechnology, and policy.
  - a. Support the Centre through funding that explores technical improvements to 2<sup>nd</sup>-generation biofuel production capabilities.
  - b. Promote cross-sectoral research partnership opportunities between Canadian and US universities and companies, which allow the lessons learned in the agricultural and chemical sectors to be applied within the Canadian forestry and energy sectors.
  - c. Include process demonstration and scale-up capacity to provide the industry with some figures on commercial applications
  - d. Create a policy research branch within this Centre that works closely with government, informs the technical research network, and determines the ability of new advancements to meet Canadian policy goals.

## 8 References

1. Atchison, J.E. (1993). In Pulp and Paper Manufacture Vol. 3, Secondary Fibers and Non-Wood Pulping, Hamilton, F., Leopold, B., and Kocurek, M.J., eds., TAPPI, Atlanta, pp. 4-16.
2. Berlin, A., Gilkes, N., Kurabi, A., Bura, R., Tu, M., Kilburn, D. and Saddler, J.N. (2005). Weak lignin-binding enzymes - A novel approach to improve activity of cellulases for hydrolysis of lignocellulosics. *Appl. Biochem. Biotechnol.* **121**: 163-170.
3. Bernotat, K. and Sandberg, T. (2004). Biomass fired small-scale CHP in Sweden and the Baltic States: a case study on the potential of clustered dwellings. *Biomass Bioenergy* **27**(6): 521-530.
4. Bowyer, J.L. and Stockmann, V.E. (2001). Agricultural residues - An exciting bio-based raw material for the global panels industry. *For. Prod. J.* **51**(1): 10-21.
5. Braune, I. (1998). The contribution of agriculture and forestry to climate protection - agriculture and forestry policy in Germany. *Berichte Uber Landwirtschaft* **76**(4), 580-597.
6. BRDTAC. (2002a). *Roadmap for biomass technologies in the United States*. Biomass Research and Development Technical Advisory Committee, Washington, DC.
7. BRDTAC. (2002b). *Vision for bioenergy and bio-based products in the United States*. Washington, DC: Biomass Research and Development Technical Advisory Committee.
8. CANUC. (2002). *Non-Food/Non-Feed Industrial Uses for Agricultural Products: Phase 1*. Ottawa, ON: Agriculture and Agri-Food Canada, Canadian New Uses Council, 84 pp.
9. CANMET. (2005). *Gasification Research*. Ottawa, ON: CANMET Energy Technology Centre. [http://www.nrcan.gc.ca/es/etb/cetc/cetc01/htmldocs/factsheet\\_gasification\\_research\\_e.html](http://www.nrcan.gc.ca/es/etb/cetc/cetc01/htmldocs/factsheet_gasification_research_e.html). Last accessed Dec. 28/05.
10. Cao, C., Wang, Y., Hu, J., Elliot, D., Jones, S., and Stevens, D. (2003). Microchannel catalytic process for converting biomass derived syngas to transportation fuels. Battelle/Pacific Northwest National Laboratory: Presentation to the ACS, New York, NY, Sept. 8 2003.
11. CCFM (2003). *Compendium of Canadian Forestry Statistics*, Canadian Council of Forest Ministers, Ottawa, ON.
12. Cetin, E., Moghtaderi, B., Gupta, R. and Wall, T.F. (2005). Biomass gasification kinetics: Influences of pressure and char structure. *Combustion Sci. Technol.* **177**(4): 765-791.
13. Coppen, J.J.W. and Hone, G.A. (1995). *Gum naval stores: Turpentine and rosin from pine resin*. Rome, Italy: Food and Agriculture Organization of the United Nations, 62 pp.
14. Crawford, C. and Canadian New Uses Council (CANUC). (2001). *Discussion Framework: Developing Biobased Industries in Canada*. Ottawa, ON: Agriculture and Agri-Food Canada, 69 pp.
15. Diertenberger, M. (2002). Update for combustion properties of wood components. *Fire Mater.* **26**: 255-267.
16. DOE. (2006a). *Advanced biorefining of distiller's grain and corn stover blends*. Washington, DC: US Department of Energy, Office of Energy Efficiency and Renewable Energy. [http://www.eere.energy.gov/biomass/pdfs/factsheets/fy04/advanced\\_biorefining.pdf](http://www.eere.energy.gov/biomass/pdfs/factsheets/fy04/advanced_biorefining.pdf). Last accessed Jan. 02/06.
17. DOE. (2006b). *Electricity from biomass*. Washington, DC: US Department of Energy; [http://eereweb.ee.doe.gov/biomass/electrical\\_power.html](http://eereweb.ee.doe.gov/biomass/electrical_power.html). Last accessed Jan. 02/06.
18. DOE. (2006c). *DOE Thermochemical Users Facility*. Washington, DC: US Department of Energy, Office of Energy Efficiency and Renewable Energy. <http://www.eere.energy.gov/biomass/pdfs/33817.pdf>. Last accessed Jan. 02/06.
19. DOE. (2006d). *Big Island Demonstration Project - Black Liquor*. Washington, DC: US Department of Energy, Office of Energy Efficiency and Renewable Energy. [http://www.eere.energy.gov/biomass/pdfs/factsheets/fy04/big\\_island\\_black\\_liquor.pdf](http://www.eere.energy.gov/biomass/pdfs/factsheets/fy04/big_island_black_liquor.pdf). Last accessed Jan. 02/06.
20. DOE. (2006e). *Gasification-based fuel conversion and electricity production in the forest products industry*. Washington, DC: US Department of Energy, Office of Energy Efficiency and Renewable Energy. [http://www.eere.energy.gov/biomass/pdfs/factsheets/fy04/gasification\\_based\\_fuel\\_conversion.pdf](http://www.eere.energy.gov/biomass/pdfs/factsheets/fy04/gasification_based_fuel_conversion.pdf). Last accessed Jan. 02/06.

21. DOE. (2006f). *Mississippi Ethanol gasification project*. Washington, DC: US Department of Energy, Office of Energy Efficiency and Renewable Energy.  
[http://www.eere.energy.gov/biomass/pdfs/factsheets/fy04/mississippi\\_ethanol\\_gasification.pdf](http://www.eere.energy.gov/biomass/pdfs/factsheets/fy04/mississippi_ethanol_gasification.pdf).  
Last accessed Jan. 02/06.
22. DOE. (2006g). *Making industrial biorefining happen!* Washington, DC: US Department of Energy, Office of Energy Efficiency and Renewable Energy.  
[http://www.eere.energy.gov/biomass/pdfs/factsheets/fy04/making\\_industrial\\_biorefinery.pdf](http://www.eere.energy.gov/biomass/pdfs/factsheets/fy04/making_industrial_biorefinery.pdf).  
Last accessed Jan. 02/06.
23. DOE. (2006h). *Integrated corn-based bio-refinery*. Washington, DC: US Department of Energy, Office of Energy Efficiency and Renewable Energy.  
[http://www.eere.energy.gov/biomass/pdfs/factsheets/fy04/integrated\\_cornbased\\_biorefinery.pdf](http://www.eere.energy.gov/biomass/pdfs/factsheets/fy04/integrated_cornbased_biorefinery.pdf).  
Last accessed Jan. 02/06.
24. DOE. (2006i). *New platform intermediates*. Washington, DC: US Department of Energy, Office of Energy Efficiency and Renewable Energy.  
[http://www.eere.energy.gov/biomass/pdfs/factsheets/fy04/new\\_platform\\_intermediates.pdf](http://www.eere.energy.gov/biomass/pdfs/factsheets/fy04/new_platform_intermediates.pdf).  
Last accessed Jan. 02/06.
25. ECN. (2005). *Phyllis, database for biomass and waste*. Petten, NL: Energy Research Centre of the Netherlands (ECN). <http://www.ecn.nl/phyllis/DataTable.asp>. Last accessed Dec. 21/05.
26. Economagic. (2006). *West Texas intermediate crude oil prices, dollars per barrel*.  
[www.economagic.com](http://www.economagic.com). Last accessed Mar. 30/06.
27. Environment Canada. (1992). *Agricultural land use change in Canada*. Ottawa, ON: Environment Canada.
28. FAO. (2006a). *FAOStat Agriculture Data*. Rome, Italy: Food and Agriculture Organization of the United Nations. Available online at [www.faostat.org](http://www.faostat.org). Last accessed March 12, 2006.
29. FAO. (2006b). *FAOStat Forestry Data*. Rome, Italy: Food and Agriculture Organization of the United Nations. Available online at [www.faostat.org](http://www.faostat.org). Last accessed March 12, 2006.
30. FAO. (2005). *State of the World's Forests*. Rome, Italy: Food and Agriculture Organization of the United Nations.
31. Faaij, A.P.C. (2006). Bio-energy in Europe: changing technology choices. *Energy Policy* **34**(3): 322-342.
32. Farahani, S., Worrell, E., and Bryntse, G. (2004). CO<sub>2</sub>-free paper? *Resources, Conservation and Recycling* **42**(4): 317-336.
33. Galbe, M. and Zacchi, G. (2002). A review of the production of ethanol from softwood. *Appl. Microbiol. Biotechnol.* **59**(6): 618-628.
34. Garcia, L., French, R., Czernik, S. and Chornet, E. (2000). Catalytic steam reforming of bio-oils for the production of hydrogen: effects of catalyst composition. *Applied Catalysis A: General* **201**(2): 225-239.
35. Gielen, D.J., de Feber, M.A., Bos, A.J. and Gerlagh, T. (2001). Biomass for energy or materials? A Western European systems engineering perspective. *Energy Policy* **29**(4): 291-302.
36. Gravitis, J., Zandersons, J., Verdernikov, N., Kruma, I., and Ozols-Kalnins, V. (2004). Clustering of bio-products technologies for zero emissions and eco-efficiency. *Ind. Crops Prod.* **20**(2): 169-180.
37. Gregg, D.J., Boussaid, A. and Saddler, J.N. (1998). Techno-economic evaluations of a generic wood-to-ethanol process: Effect of increased cellulose yields and enzyme recycle. *Bioresource Technology* **63**(1): 7-12.
38. Hamelinck, C.N., Faaij, A.P.C., den Uil H., and Boerrigter, H. (2004). Production of FT transportation fuels from biomass; technical options, process analysis and optimisation, and development potential. *Energy* **29**(11): 1743-1771.
39. IEA (2003). *Renewables Information 2003*. IEA Statistics. Paris, France, International Energy Agency.
40. Iogen. (2004). *Cellulose ethanol is ready to go*. Press Release, 21 April 2004.
41. IPCC. (2000). *Special report on emissions scenarios*. Cambridge, UK: Intergovernmental Panel on Climate Change.

42. Kahandawala, M.S., Graham, J.L. and Sidhu, S.S. (2004). Particulate emission from combustion of diesel and Fischer-Tropsch fuels: A shock tube study. *Energy & Fuels* **18**(2): 289-295.
43. Keller, F.A. (1996). Integrated bioprocess development for bioethanol production. In *Handbook on Bioethanol: Production and Utilization*. Wyman, C.E., ed. Washington, DC: Taylor & Francis, pp. 351-379.
44. Kemppainen, A.J. and Shonnard, D.R. (2005). Comparative life-cycle assessments for biomass-to-ethanol production from different regional feedstocks. *Biotechnol. Prog.* **21**(4): 1075-1084.
45. Larson, E.D., McDonald, G.W., Yang, W., Fredrick, W.M.J., Lisa, K., Kreutz, T.G., Malcolm, E.W. and Brown, C.A. (2000). A cost-benefit assessment of BLGCC technology. *Tappi J.* **83**(6): 1–16.
46. Lawford, H.G., Rousseau, J.D. and Tolan, J.S. (2001). Comparative ethanol productivities of different *Zymomonas* recombinants fermenting oat hull hydrolysate. *Applied Biochemistry and Biotechnology* **91-93**: 133-146.
47. Lawford, H.G., Rousseau, J.D., Mohagheghi, A., and McMillan, J.D. (1999). Fermentation performance characteristics of a prehydrolyzate-adapted xylose-fermenting recombinant *Zymomonas* in batch and continuous fermentations. *Applied Biochemistry and Biotechnology* **77-79**: 191-204.
48. Lindstrom, M., Skidmore, E., Gupta, S., and Onstad, C. (1979). Soil conservation limitations on removal of crop residues for energy production. *Journal of Environmental Quality* **8**(4): 533-537.
49. Lynd, L.R., Wyman, C.E., and Gerngross, T.U. (1999). Biocommodity engineering. *Biotechnol. Prog.* **15**(5): 777-793.
50. Mabee, W. E., Gregg, D. J., Arato, C., Berlin, A., Bura, R., Gilkes, N., Mirochnik, O., Pan, X., Pye, E. K. and Saddler, J. N. (2006a). Update on softwood-to-ethanol process development. *Appl. Biochem. Biotechnol.* (in press).
51. Mabee, W.E., Gregg, D.J., and Saddler, J.N. (2006b). Canadian biomass reserves for biorefining. *Appl. Biochem. Biotechnol.* (in press).
52. Mabee, W.E., Gregg, D.J., and Saddler, J.N. (2005). Assessing the emerging biorefinery sector in Canada. *Appl. Biochem. Biotechnol.* **121**: 765-778.
53. Mabee, W.E., Gregg, D.J. and Saddler, J.N. (2004). *Ethanol from lignocellulosics: Views to implementation*. Vancouver, BC, IEA Bioenergy Task 39: 90 pp.
54. MacLean, H.L. and Lave, L.B. (2003). Life cycle assessment of automobile/fuel options. *Environ. Sci. Technol.* **37**(23): 5445-5452.
55. McCloy, B.W. (2003). *Estimated Production, Consumption and Surplus Mill Residues in British Columbia – A 2003 Update*. Prepared for Natural Resources Canada. BW McCloy & Associates Inc., Vancouver, BC.
56. Novozymes. (2005). *Novozymes and NREL reduce enzyme cost*. Press Release, 14 April 2005.
57. NRCAN. (2006). *Renewable Energy Deployment Initiative*. Ottawa, ON: Natural Resources Canada, Renewable and Electrical Branch. <http://www2.nrcan.gc.ca/es/erb/erb/english/View.asp?x=455>. Last accessed Jan. 02/06.
58. NRCAN. (2005a). *Canadian Natural Gas: Review of 2004 & Outlook to 2020*. Ottawa, ON: Natural Resources Canada, Petroleum Resources Branch. <http://www2.nrcan.gc.ca/es/erb/prb/english/View.asp?x=447>. Last accessed Dec. 21/05.
59. NRCAN. (2005b). *Renewable Power Production Incentive*. Ottawa, ON: Natural Resources Canada, Electricity Resources Branch. <http://www2.nrcan.gc.ca/es/erb/erb/english/View.asp?x=681>. Last accessed Dec. 28/06.
60. NRCAN. (2003). *The State of Canada's Forests 2002-2003*, Natural Resources Canada, Ottawa, ON.
61. OBP. (2003). *Multiyear Plan – 2003 to 2008*. Office of Energy Efficiency and Renewable Energy/Office of the Biomass Program. Washington, D.C.: U.S. Department of Energy.
62. Panshin, A.J. and de Zeeuw, C. (1980). *Textbook of Wood Technology*, 4th ed., McGraw-Hill, Toronto, ON, pp. 213.
63. Prins, M.J. and Ptasinski, K.J. (2005). Energy and exergy analyses of the oxidation and gasification of carbon. *Energy* **30**(7): 982-1002.

64. Quirin, M., Gärtner, S.O., Pehnt, M. and Reinhardt, G.A. (2004). *CO<sub>2</sub> Mitigation through biofuels in the transport sector. Status and Perspectives - Main Report*. Heidelberg, Germany, Institute for Energy and Environmental Research Heidelberg: 66 pp.
65. Rosenberg, A., Kaul, H.P., Senn, T., and Aufhammer, W. (2002). Costs of bioethanol production from winter cereals: the effect of growing conditions and crop production intensity levels. *Ind. Crops Prod.* **15**(2): 91-102.
66. Sassner, P., Galbe, M., and Zacchi, G. (2005). Steam pretreatment of *Salix* with and without SO<sub>2</sub> impregnation for production of bioethanol. *Appl. Biochem. Biotechnol.* **121**: 1101-1117.
67. Schulz, M. and Hebecker, D. (2005). Thermodynamic analysis and assessment of bioethanol production. *Chemie Ingenieur Technik* **77**(6): 792-798.
68. Shanahan, J., Smith, D., Stanton, T. and Horn, B. (1999). Crop residues for livestock feed. Colorado State University Cooperative Extension. Available online at <http://www.ext.colostate.edu/pubs/livestk/00551.html>.
69. Sheehan, J.S. and Himmel, M.E. (2001). Outlook for bioethanol production from lignocellulosic feedstocks: Technology hurdles. *Agro Food Ind. Hi-Tech* **12**(5): 54-57.
70. Skog, K.E. and Rosen, H.N. (1997). United States wood biomass for energy and chemicals: Possible changes in supply, end uses, and environmental impacts. *Forest Prod. J.* **47**(2): 63-69.
71. Sjöström, E. (1993). *Wood Chemistry, Fundamentals and Application*, 2nd ed., Academic Press, New York.
72. Spath, P. and Dayton, D. (2003). *Preliminary Screening - Technical and economic assessment of synthesis gas to fuels and chemicals with emphasis on the potential for biomass-derived syngas*. Washington, DC: Department of Energy (NREL), 160 pp
73. (S&T)<sup>2</sup> and Meyers Norris Penny. (2004). *Economic, Financial, Social Analysis and Public Policies for Fuel Ethanol*. Natural Resources Canada Office of Energy Efficiency, Ottawa, ON.
74. Statistics Canada. (2004). Environmental Accounts and Statistical Division. Ottawa, ON.
75. Statistics Canada. (2003a). *CANSIM II table 051-0001*. Statistics Canada, Ottawa, ON.
76. Statistics Canada. (2003b). *Census of Agriculture*. Statistics Canada, Ottawa, ON.
77. Statistics Canada. (2000). *Human Activity and the Environment 2000*. Ottawa, ON: Statistics Canada, Catalogue No. 11-509-XPE, pp. 128-130.
78. Statistics Canada. (1990). *CANSIM table 384-0013*. Statistics Canada, Ottawa, ON.
79. Szybist, J.P., Kirby, S.R., Boehman, A.L. (2005). NO<sub>x</sub> emissions of alternative diesel fuels: A comparative analysis of biodiesel and FT diesel. *Energy & Fuels* **19**(4): 1484-1492.
80. Tijmensen, M.J.A., Faaij, A.P.C., Hamelinck, C.N., and van Hardeveld, M.R.M. (2002). Exploration of the possibilities for production of Fischer Tropsch liquids and power via biomass gasification. *Biomass Bioenergy* **23**(2): 129-152.
81. VIEWLS. (2005). *Shift gear to biofuels*. Utrecht, the Netherlands, SenterNovem: 60 pp.
82. Werpy, T., Petersen, G., Aden, A., Bozell, J., Holladay, J., White, J., Manheim, A., Elliot, D., Lasure, L., Jones, S., Gerber, M., Ibsen, K., Lumberg, L. and Kelley, S. (2004). *Top Value Added Chemicals from Biomass Volume 1: Results of screening for potential candidates from sugars and synthesis gas*. Washington, DC: Department of Energy, 76 pp.
83. Wingren, A., Galbe, M., and Zacchi, G. (2003). Techno-economic evaluation of producing ethanol from softwood: Comparison of SSF and SHF and identification of bottlenecks. *Biotechnol. Prog.* **19**: 1109-1117.
84. Wyman, C.E., Dale, B.E., Elander, R.T., Holtzapple, M., Ladisch, M.R., and Lee, Y.Y. (2005). Coordinated development of leading biomass pretreatment technologies. *Bioresource Technol.* **96**(18): 1959-1966.